



media5
corporation
Discover the Power of 5

Hardware Installation Guide

Mediatrix[®] 3700 Series **Hybrid Gateways**

Mediatrix 3716 / 3731 / 3732 / 3734 / 3741 / 3742

Product Version 2.0

Document Revision 17

March 2, 2012



Media5 Corporation
4229 Garlock Street
Sherbrooke, Québec, Canada J1L 2C8

Mediatix® 3700 Series Hardware Installation Guide

© 2012, Media5 Corporation

All rights reserved. No part of this publication may be reproduced or used in any form or by any means – graphic, electronic, or mechanical, including photocopying, recording, taping, or information storage and retrieval systems – without the express written permission of the publisher.

Media5 Corporation reserves the right to revise this publication and make changes at any time and without the obligation to notify any person and/or entity of such revisions and/or changes.

Trademarks

Microsoft and Windows are registered trademarks of Microsoft Corporation.

Adobe and Acrobat are registered trademarks of Adobe Systems Incorporated.

All other trademarks and registered trademarks are the property of their respective owners.

Third-Party Software Copyright Information

The Mediatix® 3700 Series firmware aggregates some third-party software modules (open source and commercial) that are distributed to you in accordance with their respective licenses. Refer to the *Third Party Software Copyright Information* addendum available on the Mediatix Download Portal, which lists the third-party software modules along with any copyright and license information.

Contents

Preface

About this Manual	vii
Document Objectives.....	vii
Intended Audience.....	viii
Related Documentation	viii
Document Structure.....	viii
Document Conventions	ix
Warning Definition	ix
Other Conventions	ix
SCN vs PSTN.....	x
Standards Supported	x
Obtaining Documentation	x
Media5 Web Site	x
Media5 Download Portal	x
Documentation Feedback	x
End User Technical Support.....	xi

Chapter 1

Overview	1
Overview.....	1
Key Features	2
Mediatix 3700 Connectors and Indicators	2
Product Serial Number Location	2
Front Indicators and Connectors	3
Rear Connectors and Indicators.....	4
Port Numbering Convention	10
WAN/LAN Slot – Ethernet Connectors.....	10
Service Slot 1	10
Service Slots 2/3 – PRI Connector	10
Service Slots 2/3 – BRI Connectors	11
Service Slot 3 – 7 FXS/1 FXO Connectors	11
Service Slot 3 – 2 FXS/6 FXO Connectors	11
Bypass Feature.....	12

Chapter 2

Installation	13
Planning the Installation.....	13
Installation Checklist.....	13
Site Log	14
Network Information	14
Safety Recommendations.....	14
Maintaining Safety with Electricity	14
General Safety Practices.....	15
Preventing Electrostatic Discharge Damage	15
Required Mounting Tools and Equipment	15
Unpacking and Inspection	15

Location and Mounting Requirements	17
Location	17
Mounting Brackets.....	17
Rack-Mounting	18
Wall-Mounting	19
Free Standing Unit	20
Condensation	20
Cleaning	20
Hardware Installation	21
Connecting Cables – Mediatix 3716	21
Connecting Cables – Mediatix 3731	22
Connecting Cables – Mediatix 3732	23
Connecting Cables – Mediatix 3734	24
Connecting Cables – Mediatix 3741	25
Connecting Cables – Mediatix 3742	26

Chapter 3

Powering on the Mediatix 3700..... 29

IP Address Discovery or Configuration	29
Dynamic WAN IPv4 Address Discovery	29
Default Static WAN IPv4 Address Configuration	30
IPv6 Link Local Address Configuration	31
LAN Interface Access.....	31
Vocal Unit Information	32
Verifying the Installation	32
Indicators (LEDs)	32
LED Patterns – Specific Conditions	32
LED Patterns – Default Behaviour	34
RESET/DEFAULT Button	34
At Run-Time	34
At Start-Time	35
Partial Reset.....	35
Factory Reset.....	36
Management Choices.....	36

Appendix A

Standards Compliance and Safety Information 39

Standards Supported.....	39
Disclaimers	40
Federal Communications Commission (FCC) Part 15	40
Federal Communications Commission (FCC) Part 68	40
Industry Canada	41
CE Marking.....	41
RoHS China	42
Translated Warning Definition	43
Safety Warnings	44
Circuit Breaker (15A) Warning	44
TN Power Warning	44
Product Disposal Warning.....	44
No. 26 AWG Warning.....	44
LAN and FXS Ports Connectors Warning	44
ISDN BRI Connector Warning.....	44
Socket Outlet Warning	45
Safety Recommendations.....	45

Appendix B

Cabling Considerations	47
Ethernet RJ-45 Cable	47
Straight Through Cable	48
Crossover Cable	49
BRI RJ-45 Cable	49
Straight Through Cable	49
Crossover Cable	50
E1 PRI RJ-45 Cable	51
T1 PRI RJ-45 Cable	51
RJ-11 (Telephone) Cable	52
Wiring Conventions	52
Serial Console (RS-232)	53
DTE or DCE	53
Crossover Cable (Null Modem)	53

Appendix C

Standard Hardware Information.....	55
Industry Standard Protocols	55
Hardware Features	56
Interfaces.....	56
Power	57
Product Architecture Details	57
Real Time Fax Router Technical Specifications	57
Analog Line Interface (FXS)	58
PSTN Interface (FXO)	58
Audio Specifications	59
DTMF Tone Detection	59
DTMF Tone Generation	59
Power Consumption	60
MTBF Value	60
Operating Environment	60
Dimensions and Weight	61
Warranty	61

Appendix D

Interface Card Installation Instructions.....	63
General Information	63
Interface Card Installation Instructions	63

Appendix E

Glossary	67
-----------------------	-----------

Appendix F

List of Acronyms	71
-------------------------------	-----------



About this Manual

Thank you for purchasing the Mediatix 3700 from Media5 Corporation.

The Mediatix 3700 series models offer different combinations of T1/E1, BRI and FXS interfaces in a unique analog/digital offering to allow enterprises to lower communications costs over any IP link. Designed specifically for enterprise applications, the Mediatix 3700 series models make use of existing broadband access equipment to connect to any standards-based VoIP network.

The Mediatix 3700 series models meet the requirements of enterprises that want to connect their ISDN equipment, such as PBXs, through a BRI (Basic Rate Interface) or PRI (Primary Rate Interface) interface to an IP network or as a gateway to the PSTN.

They also offer to connect analog phones, faxes, and lines to an IP network to allow cost-effective communication scenarios for immediate savings and enhanced productivity.

Table 1: Mediatix 3700 Models

Model	Interfaces	VoIP Calls Capacity	Service Slot Used
Mediatix 3716	6 FXO ports + 2 FXS ports 1 FXO port + 7 FXS ports	Up to 16	Slots 2 and 3
Mediatix 3731	1xT1/E1 PRI interface 1 FXO port + 7 FXS ports	up to 37	Slots 2 and 3
Mediatix 3732	6 FXO ports + 2 FXS ports 1xT1/E1 PRI interface	Up to 38	Slots 2 and 3
Mediatix 3734	1xT1/E1 PRI interface 5 BRI ports	up to 38	Slots 2 and 3
Mediatix 3741	1 FXO port + 7 FXS ports 5 BRI ports	up to 15	Slots 2 and 3
Mediatix 3742	6 FXO ports + 2 FXS ports 5 BRI ports	Up to 15	Slots 2 and 3

With FXO interfaces, it is the ideal solution to deploy private or hosted toll bypass networks. It provides a simple, transparent and cost-effective way of maintaining a connection to the PSTN.

Document Objectives

The *Mediatix 3700 Hardware Installation Guide* provides technical information on how to physically install the Mediatix 3700. It also describes the cabling required for the Mediatix 3700 device.

The information included in this guide consists of:

- ▶ Hardware descriptions of the Mediatix 3700 device
- ▶ Hardware installation instructions
- ▶ Installation scenarios examples
- ▶ LED indications

- ▶ Cabling and pin-out data



Note: There are many flavours of the Mediatrix 3700 device. Because of this, some of the information provided may not apply to your particular Mediatrix 3700 device model.

Please refer to the *Dgw v2.0 Software Configuration Guide* for software configuration information.

Use the *Mediatrix 3700 Hardware Installation Guide* in conjunction with the appropriate publications listed in [“Related Documentation” on page viii](#).

Intended Audience

This guide is intended for the following audiences:

- ▶ Technical staff who are familiar with electronic circuitry, networking theory and have experience as an electronic technician.
- ▶ System administrators with a basic networking background and experience, but who might not be familiar with the Mediatrix 3700 device.
- ▶ System administrators who are responsible for installing and configuring networking equipment and who are familiar with the Mediatrix 3700 device.

Related Documentation

In addition to this manual, the Mediatrix 3700 document set includes the following:

- ▶ *Dgw v2.0 Software Configuration Guide*
Describes how to configure and operate the Mediatrix 3700.
- ▶ *Mediatrix 3700 Installation Guide*
This booklet allows you to quickly setup and work with the Mediatrix 3700. The booklet for your specific platform is available at: <http://www.media5corp.com/quickstart>
- ▶ *Configuration Reference Guide*
Lists all the parameters, tables, and commands available in the Mediatrix 3700.
- ▶ *Notification Reference Guide*
Lists and describes all syslog messages and notification messages that the Mediatrix 3700 may send.
- ▶ *Third Party Software Copyright Information*
This document lists the third-party software modules used in the Mediatrix 3700 along with any copyright and license information. This document is available at: http://www.media5corp.com/repository/common%20manuals/Third-Party_Software_Copyright_Information_Mediatrix.pdf.

Be sure to read any readme files, technical bulletins, or additional release notes for important information.

Document Structure

The Mediatrix 3700 *Hardware Installation Guide* contains the following information.

Table 2: Mediatrix 3700 Hardware Installation Guide Chapter/Appendices

Title	Summary
“Chapter 1 - Overview” on page 1	Provides a brief description of the Mediatrix 3700.

Table 2: Mediatrix 3700 Hardware Installation Guide Chapter/Appendices (Continued)

Title	Summary
“Chapter 2 - Installation” on page 13	Contains instructions for installing the Mediatrix 3700 and connecting the cables.
“Chapter 3 - Powering on the Mediatrix 3700” on page 29	Leads you through the basic steps to start the Mediatrix 3700.
“Appendix A - Standards Compliance and Safety Information” on page 39	Lists the various standards compliance of the Mediatrix 3700.
“Appendix B - Cabling Considerations” on page 47	Describes the pin-to-pin connections for cables used with the Mediatrix 3700.
“Appendix C - Standard Hardware Information” on page 55	Lists the technical hardware information of the Mediatrix 3700.
“Appendix D - Interface Card Installation Instructions” on page 63	Describes how to install interface cards in a Mediatrix 3700 unit.

Document Conventions

The following information provides an explanation of the symbols that appear on the Mediatrix 3700 and in the documentation for the product.

Warning Definition



Warning: Means danger. You are in a situation that could cause bodily injury. Before you work on any equipment, you must be aware of the hazards involved with electrical circuitry and be familiar with standard practices for preventing accidents.

Where to find Translated Warning Definition

For safety and warning information, see [“Appendix A - Standards Compliance and Safety Information” on page 39](#).

This Appendix describes the international agency compliance and safety information for the Mediatrix 3700. It also includes a translation of the safety warning listed in the previous section.

Other Conventions

The following are other conventions you will encounter in this manual.



Caution: Indicates a potentially hazardous situation which, if not avoided, may result in minor or moderate injury and/or damage to the equipment or property.



Note: Indicates important information about the current topic.

Standards Supported

Indicates which RFC, Draft or other standard document is supported for a specific feature.

SCN vs PSTN

In Media5' and other vendor's documentation, the terms SCN and PSTN are used. A SCN (Switched Circuit Network) is a general term to designate a communication network in which any user may be connected to any other user through the use of message, circuit, or packet switching and control devices. The Public Switched Telephone Network (PSTN) or a Private Branch eXchange (PBX) are examples of SCNs.

Standards Supported

When available, this document lists the standards onto which features are based. These standards may be RFCs (Request for Comments), Internet-Drafts, or other standards.

The Mediatrix 3700's implementations are **based** on the standards, so it's possible that some behaviour differs from the official standards.

For more information on and a list of RFCs and Internet-Drafts, refer to the IETF web site at <http://www.ietf.org>.

Obtaining Documentation

These sections explain how to obtain documentation from Media5.

Media5 Web Site

Media5 offers the latest version of its products' documentation on its web site. You will thus be able to access and download the most current Media5 documentation. Follow this link: <http://www.media5corp.com/en/documentation>.



Note: This site does not contain any firmware versions.

Media5 Download Portal

Media5 offers online documentation via a self register web-portal. You will thus be able to access and download the most current Media5 documentation. Follow this link to register: <http://www.media5corp.com/en/support-portal>.



Note: This site does not contain any firmware versions.

Documentation Feedback

Media5 welcomes your evaluation of this manual and any suggestions you may have. These help us to improve the quality and usefulness of our publications.

Please send your comments to:

Media5 Corporation
Attention: Documentation Department
4229, Garlock Street
Sherbrooke, Quebec
Canada J1L 2C8
Fax: +1 (819) 829-5100

We appreciate your comments.

End User Technical Support

In order to maximize technical support resources, Media5 works through its partners to resolve technical support issues. All end users requiring technical support are encouraged to contact their vendor directly.

This chapter describes the Mediatrix 3700 connectors and indicators.

Overview

Provider-specific profiles ensure that the Mediatrix 3700 is a genuine plug and play solution. It offers a low total cost of ownership as it reduces installation and maintenance costs. Moreover, the Mediatrix 3700 integrates features such as TLS, SRTP, and HTTPS designed to bring enhanced security for network management, SIP signalling and media transmission aspects.

The Mediatrix 3700 models offer different combinations of T1/E1, BRI and FXS interfaces in a unique analog/digital offering to allow enterprises to lower communications costs over any IP link. Designed specifically for enterprise applications, the Mediatrix 3700 models make use of existing broadband access equipment to connect to any standards-based VoIP network.

The Mediatrix 3700 models meet the requirements of enterprises that want to connect their ISDN equipment, such as PBXs, through a BRI (Basic Rate Interface) or PRI (Primary Rate Interface) interface to an IP network or as a gateway to the PSTN.

They also offer to connect analog phones, faxes, and lines to an IP network to allow cost-effective communication scenarios for immediate savings and enhanced productivity.

The Mediatrix 3716, 3731, 3732, 3741, and 3742 models offer true FXO interfaces, which makes them the ideal solution to deploy private or hosted toll bypass networks. They provide a simple, transparent and cost-effective way of maintaining a connection to the PSTN.

The FXO interfaces provide a gateway to the PSTN for IP-based PBX and Key Systems. Thereby, Mediatrix 3700 gateways with FXO interfaces allow the deployment of VoIP Remote Line Extension and Branch Office Connectivity solutions without sacrificing any local PSTN access points.

By connecting CO lines from a selected site to VoIP networks, the Mediatrix 3700 models enable service providers and enterprises to use VoIP connections between pre-determined local networks.

The following are the Mediatrix 3700 models currently available:

Table 3: Mediatrix 3700 Models

Model	Interfaces	VoIP Calls Capacity	Service Slot Used
Mediatrix 3716	6 FXO ports + 2 FXS ports 7 FXS ports + 1 FXO port	Up to 16	Slots 2 and 3
Mediatrix 3731	1xT1/E1 PRI interface 7 FXS Lines 1 FXO Line	up to 37	Slots 2 and 3
Mediatrix 3732	6 FXO ports + 2 FXS ports 1xT1/E1 PRI interface	Up to 38	Slots 2 and 3
Mediatrix 3734	1xT1/E1 PRI interface 5 BRI ports	up to 38	Slots 2 and 3
Mediatrix 3741	7 FXS Lines 1 FXO Line 5 BRI ports	up to 15	Slots 2 and 3

Table 3: Mediatrix 3700 Models (Continued)

Model	Interfaces	VoIP Calls Capacity	Service Slot Used
Mediatrix 3742	6 FXO ports + 2 FXS ports 5 BRI ports	Up to 15	Slots 2 and 3

Key Features

- ▶ IP connectivity for analog phones and faxes
- ▶ Up to 38 simultaneous calls
- ▶ FXS interface ports
- ▶ FXO interface ports
- ▶ ISDN BRI and T1/E1 PRI interface ports
- ▶ HTTP, SNMP, FTP and TFTP for configuration and management
- ▶ True Plug-and-Play
- ▶ Automatic configuration script download
- ▶ Call Routing service
- ▶ Secure SIP signalling
- ▶ Secure Media transmission
- ▶ SNMPv3 and web management
- ▶ DHCP Client
- ▶ PPPoE Client
- ▶ T.38 support
- ▶ Command Line Interface (CLI)
- ▶ SSL/TLS Encryption

Mediatrix 3700 Connectors and Indicators

This section provides an overview of the front and rear panels of the Mediatrix 3700. The rear panel differs depending on the Mediatrix 3700 model you have.

Product Serial Number Location

The serial number label for the Mediatrix 3700 device is located on the bottom of the unit.

Front Indicators and Connectors

See [“Indicators \(LEDs\)” on page 32](#) for a description of the LED patterns the Mediatrrix 3700 may have and the states they represent.

Figure 1: Front Panel Indicators

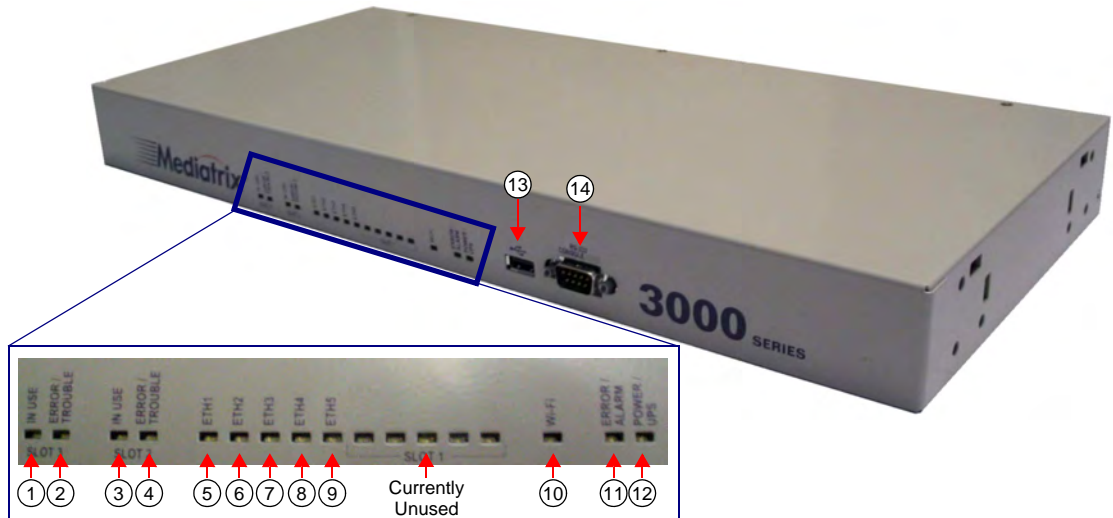

See [“Rear Connectors and Indicators” on page 4](#) for a description of the Mediatrrix 3700 Service Slot sections for your specific model.

Front LEDs

All indicators (LEDs) located on the front panel are also duplicated on the rear of the Mediatrrix 3700, which allows you to rack-mount the unit with the front or rear facing forwards. See [“Location and Mounting Requirements” on page 17](#) for more details.

[Table 4](#) describes the LEDs on the front panel of the Mediatrrix 3700.

Table 4: Front Panel LEDs

	LED	Description
1.	IN USE	When lit: <ul style="list-style-type: none"> ▶ at least one of the FXS or FXO lines of Service Slot 3 is in use (Mediatrrix 3716/3731/3732/3741/3742). ▶ at least one of the channels of the BRI connectors in Service Slot 3 is in use (Mediatrrix 3734).
2.	ERROR/TROUBLE	This LED is not currently used on the Mediatrrix 3700.
3.	IN USE	When lit: <ul style="list-style-type: none"> ▶ at least one of the FXS or FXO lines of Service Slot 2 is in use (Mediatrrix 3716). ▶ at least one of the channels of the E1/T1 connector in Service Slot 2 is in use (Mediatrrix 3731/3732/3741/3742). ▶ at least one of the channels of the BRI connectors in Service Slot 2 is in use (Mediatrrix 3741/3742).
4.	ERROR/TROUBLE	This LED is not currently used on the Mediatrrix 3700.

Table 4: Front Panel LEDs (Continued)

	LED	Description
5. 6. 7. 8.	ETH 1-4	Provides the state of the LAN network connected to the <i>ETH 1-4</i> connectors: <ul style="list-style-type: none"> Green: The Mediatrix 3700 uses a 10 Mbps connection. Yellow: The Mediatrix 3700 uses a 100 Mbps connection. The LED remains ON to indicate a Link and blinks if traffic passes.
9.	ETH 5	Provides the state of the WAN network connected to the <i>ETH 5</i> connector: <ul style="list-style-type: none"> Green: The Mediatrix 3700 uses a 10 Mbps connection. Yellow: The Mediatrix 3700 uses a 100 Mbps connection. The LED remains ON to indicate a Link and blinks if traffic passes.
10.	WI/FI	This LED is not currently used on the Mediatrix 3700.
11.	ERROR/ ALARM	This LED is not currently used on the Mediatrix 3700.
12.	POWER/ UPS	Indicates the status of the power feeding: <ul style="list-style-type: none"> Green: The Mediatrix 3700 is powered by its power supply. Yellow: The Mediatrix 3700 is powered by an external UPS.

Front Connectors

[Table 5](#) describes the connectors on the front panel of the Mediatrix 3700.

Table 5: Front Panel Connectors

	Connector	Description
13.	USB	USB 2.0 Type A connector.
14.	RS-232	RS-232 connector that connects the Mediatrix 3700 with a serial terminal such as a PC or workstation with a RS-232 interface. You must use a cross-over or null-modem cable.

Rear Connectors and Indicators

Standards Supported	<ul style="list-style-type: none"> ETSI 300 753: Acoustic Noise
----------------------------	--

The following are the rear connectors and indicators of the Mediatrix 3716 / 3731 / 3732 / 3734 / 3741 / 3742 models.

All LEDs located on the front panel are also duplicated on the rear of the Mediatrix 3700, which allows you to rack-mount the unit with the front or rear facing forwards. See [“Location and Mounting Requirements” on page 17](#) for more details.

The Mediatrix 3700 has four main sections on its rear panel. These sections may or may not be available depending on your Mediatrix 3700 model:

- ▶ WAN/LAN Slot: Contains the Ethernet connectors and their associated LEDs.
- ▶ Service Slot 1: Currently unused.
- ▶ Service Slot 2:
 - Contains 7 x FXS connectors and 1 x FXO connector (Mediatrix 3716).
 - Contains 1 x E1/T1 connector (Mediatrix 3731 / Mediatrix 3732 / Mediatrix 3734).
 - Contains 5 x BRI connectors (Mediatrix 3741 / Mediatrix 3742).
- ▶ Service Slot 3:
 - Contains 5 x BRI connectors (Mediatrix 3734).
 - Contains 7 x FXS connectors and 1 x FXO connector (Mediatrix 3731 / Mediatrix 3741).

- Contains 2 x FXS connectors and 6 x FXO connectors (Mediatrix 3716 / Mediatrix 3732 / Mediatrix 3742).

Figure 2: Mediatrix 3716 Slot Sections

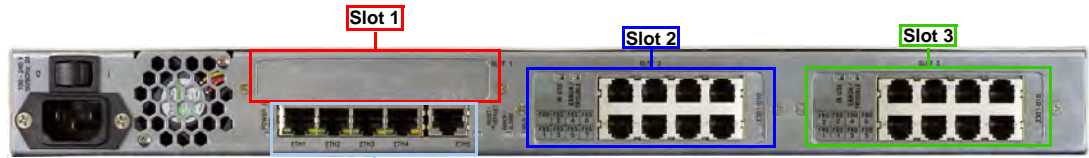

Figure 3: Mediatrix 3731 Slot Sections

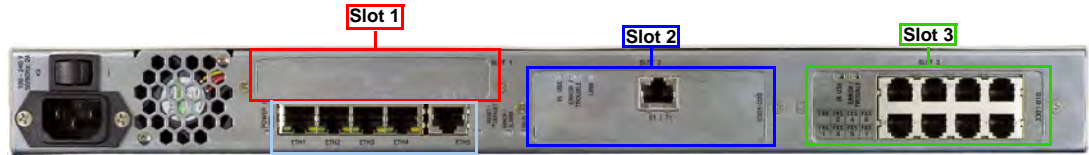

Figure 4: Mediatrix 3732 Slot Sections

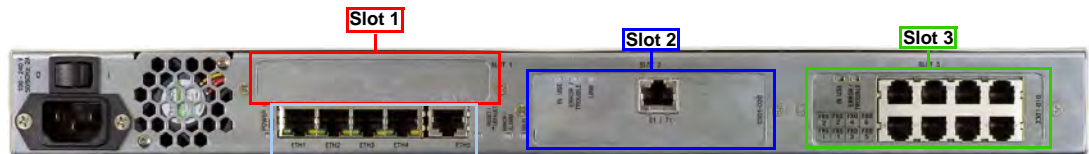

Figure 5: Mediatrix 3734 Slot Sections

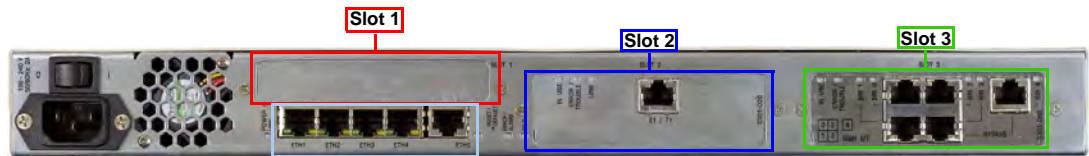

Figure 6: Mediatrix 3741 Slot Sections

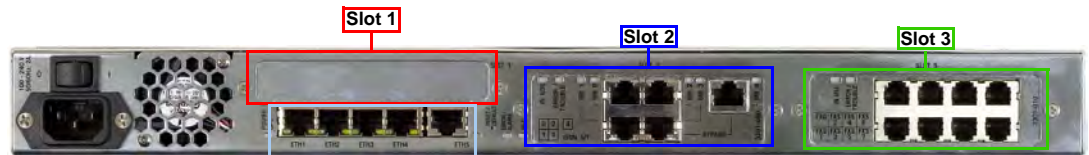
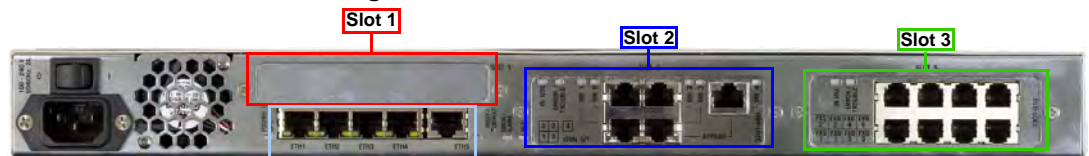

Figure 7: Mediatrix 3742 Slot Sections



The following table illustrates the connectors available per model.

Table 6: Mediatrix 3700 Connectors Available

Connector Types	3716		3731		3732		3734		3741		3742	
	S2 ^a	S3 ^b	S2	S3	S2	S3	S2	S3	S2	S3	S2	S3
1 x E1/T1			✓		✓		✓					
5 x BRI connectors							✓		✓		✓	
7 x FXS connectors + 1 x FXO connector	✓			✓						✓		

Table 6: Mediatrix 3700 Connectors Available (Continued)

Connector Types	3716		3731		3732		3734		3741		3742	
	S2 ^a	S3 ^b	S2	S3	S2	S3	S2	S3	S2	S3	S2	S3
2 x FXS connectors + 6 x FXO connectors		✓				✓						✓

- a. Slot 2
- b. Slot 3

Power and WAN/LAN Slot

This sections describes the connectors and indicators common to all Mediatrix 3700 models.

Figure 8: Mediatrix 3700 Models Rear Panel Common Connectors and Indicators

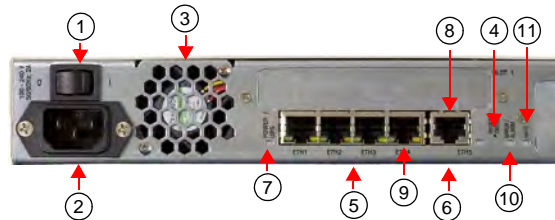



Table 7: Mediatrix 3700 Rear Panel Common Connectors and Indicators

Item	Description	
1.	On/Off Switch	Turns the Mediatrix 3700 on or off.
2.	Power connector	Standard universal input (100-240 VAC; 50-60 Hz; 2A) power supply.
3.	Fan	Variable speed fan. The noise level complies with the ETSI 300 753 standard (63 dB for office, 75 dB for telecom environment).
4.	Reset Default button	Resets configuration parameters of the Mediatrix 3700 to default (known) values. It can be used to reconfigure the unit. See “RESET/DEFAULT Button” on page 34 for more details.
WAN/LAN Connectors		
5.	ETH 1-4 Connectors	Four 10/100 BaseT Ethernet RJ-45 connectors for access to a LAN. See “WAN/LAN Slot – Ethernet Connectors” on page 10 for more details. Note: These connectors are only used to contact the unit on the LAN side.
6.	ETH 5 Connector	One 10/100 BaseT Ethernet RJ-45 connector for access to a WAN. See “WAN/LAN Slot – Ethernet Connectors” on page 10 for more details.
7.	POWER/UPS LED	Indicates the status of the power feeding: <ul style="list-style-type: none"> • Green: The Mediatrix 3700 is powered by its power supply. • Yellow: The Mediatrix 3700 is powered by an external UPS.

Table 7: Mediatrix 3700 Rear Panel Common Connectors and Indicators (Continued)

	Item	Description
8.	LAN LED	Two indicators directly incorporated into each LAN connector that provide the state of the LAN network connected to it: <ul style="list-style-type: none"> Green LED: The Mediatrix 3700 uses a 10 Mbps connection. Yellow LED: The Mediatrix 3700 uses a 100 Mbps connection.  <p>The LEDs remain ON to indicate a Link and blink if traffic passes.</p>
9.	WAN LED	Provides the state of the WAN network connected to the <i>ETH 5</i> connector: <ul style="list-style-type: none"> Green: The Mediatrix 3700 uses a 10 Mbps connection. Yellow: The Mediatrix 3700 uses a 100 Mbps connection. The LED remains ON to indicate a Link and blinks if traffic passes.
10.	ERROR/ ALARM LED	This LED is not currently used on the Mediatrix 3700.
11.	Wi-Fi LED	This LED is not currently used on the Mediatrix 3700.

E1 / T1 Connector and Indicators

This sections describes the E1 / T1 connector and indicators available on the Mediatrix 3731 / 3732 / 3734 models.

Figure 9: Mediatrix 3700 Models E1 / T1 Connector and Indicators

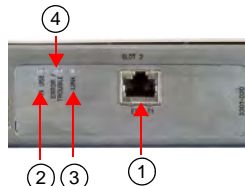

Table 8: Mediatrix 3700 Rear Panel E1 / T1 Connector and Indicators

	Item	Description
1.	E1 / T1 Connector	One RJ-45 connector offering E1/T1 ISDN connectivity. See “Service Slots 2/3 – PRI Connector” on page 10 for more details.
2.	IN USE LED	When lit, at least one of the channels of the E1/T1 connector of Service Slot 3 is in use.
3.	ERROR/ TROUBLE LED	This LED is not currently used on the Mediatrix 3700.
4.	LINK LED	Indicates the state of the ISDN network connected to this connector: <ul style="list-style-type: none"> Yellow LED: The connection has a Loss of Signal (LOS). Green LED: The connection works properly.

BRI Connectors and Indicators

This sections describes the BRI connectors and indicators available on the Mediatrix 3734 / 3741 / 3742 models.

Figure 10: Mediatrix 3700 Models BRI Connectors and Indicators

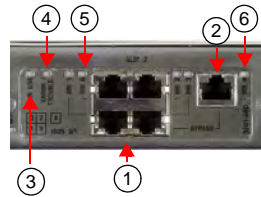

Table 9: Mediatrix 3700 Rear Panel BRI Connectors and Indicators

Item	Description
1.	BRI Connectors Four RJ-11 connectors to attach BRI lines. See “Refer to the Software Configuration Guide for more details. Also refer to “Appendix B - Cabling Considerations” on page 47 for information on the proper cabling.” on page 10 for more details.
2.	Bypass Connector One RJ-11 connector offering a metallic bypass relay between the Bypass port and the BRI # 4 port of this Slot. See “Bypass Feature” on page 12 for more details.
3.	IN USE LED When lit, at least one of the channels of the BRI connectors of Service Slot 3 is in use.
4.	ERROR/TROUBLE LED This LED is not currently used on the Mediatrix 3700.
5.	BRI LED Indicates the state of each BRI connector: <ul style="list-style-type: none"> • Yellow LED: The connection has a Loss of Signal (LOS). • Green LED: The connection works properly.
6.	Bypass LED Indicates the state of the Bypass network: <ul style="list-style-type: none"> • Yellow LED: The connection has a Loss of Signal (LOS). • Green LED: The connection works properly.

FXS/FXO Connectors and Indicators

This sections describes the FXS and FXO connectors and indicators available on the Mediatrix 3716, Mediatrix 3731 and Mediatrix 3741 models.

Figure 11: Mediatrix 3700 Models Rear Panel FXS/FXO Connectors and Indicators

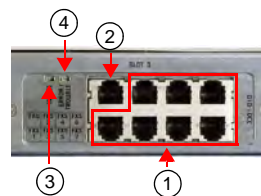

Table 10: Mediatrix 3700 Rear Panel FXS Connectors and Indicators

Item	Description
1.	FXS connectors Seven RJ-11 connectors to attach conventional telephones or G3 fax machines. See “Service Slot 3 – 7 FXS/1 FXO Connectors” on page 11 for more details.

Table 10: Mediatrix 3700 Rear Panel FXS Connectors and Indicators (Continued)

	Item	Description
2.	FXO connector	One RJ-11 connector offering SCN access for various VoIP endpoints such as IP phones, FXS devices, softphones and IP-based PBX and Key Systems. See “Service Slot 3 – 7 FXS/1 FXO Connectors” on page 11 for more details.
3.	IN USE LED	When lit, at least one of the lines of Service Slot 3 is in use.
4.	ERROR/TROUBLE LED	This LED is not currently used on the Mediatrix 3700.

2 FXS/6 FXO Card Connectors and Indicators

This sections describes the FXS and FXO connectors and Indicators available on the Mediatrix 3716, Mediatrix 3732 and Mediatrix 3742 models.

Figure 12: Mediatrix 3700 Models Rear Panel FXS/FXO Connectors and Indicators

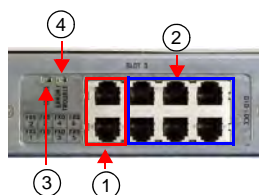

Table 11: Mediatrix 3700 Rear Panel FXS/FXO Connectors and Indicators

	Item	Description
1.	FXS connectors	Two RJ-11 connectors to attach conventional telephones or G3 fax machines. See “Service Slot 3 – 2 FXS/6 FXO Connectors” on page 11 for more details.
2.	FXO connector	Six RJ-11 connector offering SCN access for various VoIP endpoints such as IP phones, FXS devices, softphones and IP-based PBX and Key Systems. See “Service Slot 3 – 2 FXS/6 FXO Connectors” on page 11 for more details.
3.	IN USE LED	When lit, at least one of the lines of Service Slot 3 is in use.
4.	ERROR/TROUBLE LED	This LED is not currently used on the Mediatrix 3700.

Port Numbering Convention

The following describes the port numbering conventions of the Slot sections.

WAN/LAN Slot – Ethernet Connectors

Standards Supported

- IEEE 802.3: LAN/MAN CSMA/CD Access Method
- EIA/TIA 568-A: Commercial Building Wiring Standard

The following describes the port numbering conventions of the Ethernet connectors.

Figure 13: Ethernet Connectors Port Numbering Conventions

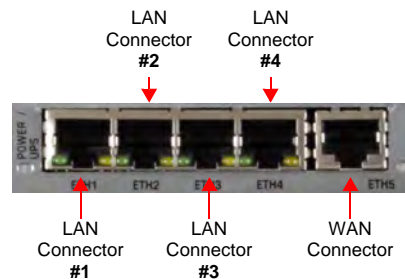

Note: The LAN connectors are used to contact the unit on the LAN side. They can also be used as a SIP gateway to be bound on the LAN. However, there is no routing between the LAN and the uplink interface.

Service Slot 1

This slot is currently unused.

Service Slots 2/3 – PRI Connector

Standards Supported

- EIA/TIA-464-B: Requirements for Private Branch Exchange (PBX) Switching Equipment

The E1 / T1 card has only one PRI connector. This connector has software configurable pin outs, and can be set in either Network or User mode.

- ▶ User mode: The connector emulates the subscriber (terminal) side of the digital connection. You can connect the SCN to the connector.
- ▶ Network mode: The connector emulates the central office (network) side of the digital connection. You can connect a PBX to the connector.

Refer to the *Software Configuration Guide* for more details. Also refer to [“Appendix B - Cabling Considerations” on page 47](#) for information on the proper cabling.

Service Slots 2/3 – BRI Connectors

The following describes the port numbering conventions of the BRI connectors.

Figure 14: BRI Connectors Port Numbering Conventions

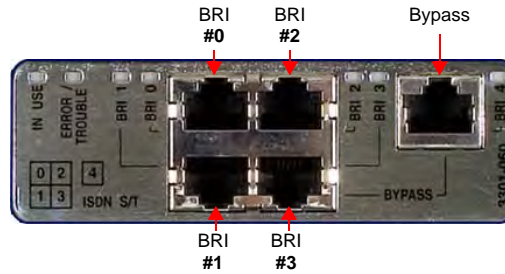

The BRI ports have software configurable pin outs, and can be set in either Network or User mode.

- ▶ User mode: The connector emulates the subscriber (terminal) side of the digital connection. You can connect the SCN to the connector.
- ▶ Network mode: The connector emulates the central office (network) side of the digital connection. You can connect a PBX or ISDN telephones to the connector.

Refer to the *Software Configuration Guide* for more details. Also refer to [“BRI RJ-45 Cable” on page 49](#) for information on the proper cabling.

Service Slot 3 – 7 FXS/1 FXO Connectors

The following describes the port numbering conventions of the FXS/FXO connectors.

Figure 15: FXS/FXO Connectors Port Numbering Convention

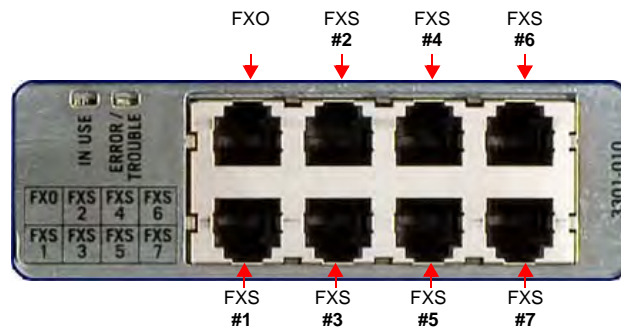

Service Slot 3 – 2 FXS/6 FXO Connectors

The following describes the port numbering conventions of the 2 FXS/6 FXO card connectors.

Figure 16: 2 FXS/6 FXO Connectors Port Numbering Convention

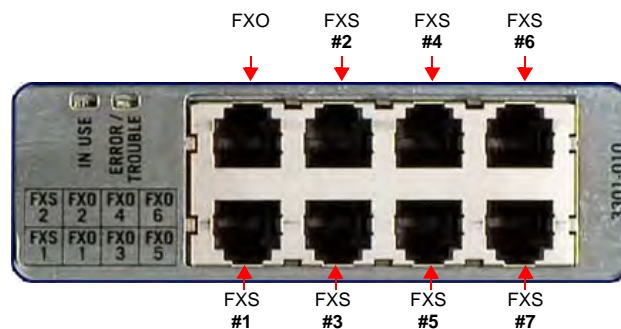

Bypass Feature



Note: This section applies to the Mediatrix 3734, Mediatrix 3741 and Mediatrix 3742 models.

In the event of a power failure or network failure, the bypass feature permits users to make and receive calls even when the Mediatrix 3700 is not operating. The Mediatrix 3700 **BRI 3** and **BRI 4** connectors may either act as a SCN bypass. For instance, if you decide to connect a SCN line into the *BRI 4* connector, you can use a BRI telephone connected into the *BRI 3* connector to make calls.

Furthermore:

- ▶ The connector on which the SCN line is connected must be configured as a TE.
- ▶ The other connector must be configured as a NT.

Refer to the *Software Configuration Guide* for more details on how to configure the line type.

During normal operation, the direct connection between the *BRI 3* and *BRI 4* connectors is switched out through commuting relays and both ports resume normal functions. When power is removed from the Mediatrix 3700, the relay setting is restored to a connected state and the SCN line can be used as an emergency line. Consequently, a BRI telephone used on the other port is directly connected to this SCN line. When the power is restored, this automatically removes the Bypass connection; this means that any ongoing call on the Bypass connection is terminated.



Note: If you are using a crossover Ethernet cable to connect the SCN line to the Mediatrix 3700 and there is a power failure, the bypass feature does not work properly.

This chapter describes the installation of the Mediatrix 3700.

Planning the Installation

Before installing the Mediatrix 3700, you should complete the following tasks:

- ▶ Create a network diagram (see section [“Network Diagram” on page 14](#)).
- ▶ Gather IP-related information (see section [“IP-Related Information” on page 14](#) for more information).
- ▶ Install the hardware and software needed to configure the Mediatrix 3700 (see section [“Network Information” on page 14](#)).

Installation Checklist

The installation checklist lists the tasks for installing the Mediatrix 3700. Print a copy of this checklist and mark the entries as you complete each task. Include the completed checklist in your site log.

Figure 17: Installation Checklist

Mediatrix 3700 name/serial number _____

Task	Verified By	Date
Network information available & recorded in site log		
Environmental specifications verified		
Site power voltages verified		
Installation site pre-power check completed		
Required tools available		
Additional equipment available		
Mediatrix 3700 received		
Quick start guide received		
Regulatory compliance and safety information received		
Warranty card received		
Software version verified		
Rack, desktop, or wall mounting of chassis completed		
Initial electrical connections established		
ASCII terminal attached to console port		
Cable length limits verified		
Initial configuration performed		
Initial operation verified		

Site Log

Media5 recommends that you maintain a site log to record all actions relevant to the Mediatrix 3700, such as:

- ▶ Installation: Print a copy of the installation checklist and insert it into the site log.
- ▶ Upgrades and maintenance: Use the site log to record ongoing maintenance and expansion history. Update the site log to reflect the following:
 - Configuration changes
 - Maintenance schedules, requirements, and procedures performed
 - Comments, notes, and problems
 - Software changes and updates to firmware

Network Information

When planning the installation of the Mediatrix 3700, you should consider the following network information.

Network Diagram

It is always good practice to draw a network overview diagram that displays all neighbouring IP nodes, serial connected elements, and other components. It is recommended that you keep a copy in the site log (see [“Site Log” on page 14](#) for more information on keeping a site log).

IP-Related Information

Before you can install the Mediatrix 3700, you need to have the following information:

- ▶ IP addresses used for Ethernet LAN and WAN connectors
- ▶ Subnet mask used for Ethernet LAN and WAN connectors
- ▶ IP addresses of the central SIP server
- ▶ IP addresses of the central server used for configuration upload and download

Power Source

If you suspect that your AC power is not reliable, for example if room lights flicker often or there is machinery with large motors nearby, have a qualified professional test the power. Install a power conditioner if necessary.

Safety Recommendations

The following are safety recommendations and best practices to follow when working with the Mediatrix 3700.

Maintaining Safety with Electricity



Warning: Do not work on the Mediatrix 3700, connect or disconnect cables during periods of lightning activity.



Warning: Disconnect all power before servicing the Mediatrix 3700.



Warning: Hazardous network voltages might be present in WAN, LAN, and telephone networks connectors regardless of whether power to the device is OFF or ON. Use caution when working near these connectors to avoid electric shock. When detaching cables, detach the end away from the Mediatrix 3700 first.

General Safety Practices

Follow these guidelines to ensure personal safety and protect the equipment:

- ▶ Keep the Mediatrix 3700 clear and dust-free during and after installation.
- ▶ Locate the emergency power-off switch for the room in which you are working. Then, if an electrical accident occurs, you can act quickly to turn off the power.
- ▶ Disconnect all power before installing the Mediatrix 3700.
- ▶ Do not work alone if potentially hazardous conditions exist.
- ▶ Never assume that power is disconnected from a circuit. Always check.
- ▶ Do not perform any action that creates a potential hazard to people or makes equipment unsafe.



Warning: This equipment must be installed and maintained by service personnel. Incorrectly connecting this equipment to a general-purpose outlet could be hazardous. The telecommunications lines must be disconnected before unplugging the main power connector.

Preventing Electrostatic Discharge Damage

Always follow electrostatic discharge (ESD) prevention procedures when installing or working around the Mediatrix 3700.

- ▶ Ensure that the Mediatrix 3700 chassis is electrically connected to earth ground.
- ▶ Wear an ESD-preventive wrist strap, ensuring that it makes good skin contact. Connect the clip to earth ground to channel unwanted ESD voltages to ground safely. If no ESD wrist strap is available, ground yourself by touching the metal part of the chassis.

Required Mounting Tools and Equipment

You will need the following tools and parts to properly install the Mediatrix 3700:

- ▶ Screwdriver as required for attaching brackets to rack or wall.
- ▶ Philips screwdriver for attaching brackets to the Mediatrix 3700.
- ▶ Screws and anchors for wall-mounting, if required.
 - Four wood screws or other fasteners, for installing the chassis on a wall.
- ▶ ESD-preventive wrist strap.

In addition, you might need the following external equipment:

- ▶ Modem for remote access.
- ▶ RJ-45 cables for the WAN and LAN connections.

Unpacking and Inspection

If you haven't already done so, unpack the Mediatrix 3700 device. Carefully remove it from the package and packing material. The Mediatrix 3700 package contains the following items:

- ▶ **Mediatrix 3716**
 - ▶ 1 x Mediatrix 3716 unit
 - ▶ 1 x power cord for the country in which you are using the Mediatrix 3716
 - ▶ 1 x wall/rack mounting kit
 - ▶ 1 x Bumpon™ kit for desktop use
 - ▶ 1 x 10/100 BaseT Ethernet RJ-45 cable gray
 - ▶ 1 x Printed Flyer

▶ Mediatrix 3731

- ▶ 1 x Mediatrix 3731 unit
- ▶ 1 x power cord for the country in which you are using the Mediatrix 3731
- ▶ 1 x wall/rack mounting kit
- ▶ 1 x Bumpon™ kit for desktop use
- ▶ 1 x 10/100 BaseT Ethernet RJ-45 cable gray
- ▶ 1 x 10/100 BaseT Ethernet RJ-45 cable black (PRI Cable)
- ▶ 1 x Printed Flyer

▶ Mediatrix 3732

- ▶ 1 x Mediatrix 3732 unit
- ▶ 1 x power cord for the country in which you are using the Mediatrix 3732
- ▶ 1 x wall/rack mounting kit
- ▶ 1 x Bumpon™ kit for desktop use
- ▶ 1 x 10/100 BaseT Ethernet RJ-45 cable gray
- ▶ 1 x 10/100 BaseT Ethernet RJ-45 cable black (PRI Cable)
- ▶ 1 x Printed Flyer

▶ Mediatrix 3734

- ▶ 1 x Mediatrix 3734 unit
- ▶ 1 x power cord for the country in which you are using the Mediatrix 3734
- ▶ 1 x wall/rack mounting kit
- ▶ 1 x Bumpon™ kit for desktop use
- ▶ 1 x 10/100 BaseT Ethernet RJ-45 cable gray
- ▶ 6 x 10/100 BaseT Ethernet RJ-45 cables black (PRI Cable)
- ▶ 1 x Printed Flyer

▶ Mediatrix 3741

- ▶ 1 x Mediatrix 3741 unit
- ▶ 1 x power cord for the country in which you are using the Mediatrix 3741
- ▶ 1 x wall/rack mounting kit
- ▶ 1 x Bumpon™ kit for desktop use
- ▶ 1 x 10/100 BaseT Ethernet RJ-45 cable gray
- ▶ 5 x 10/100 BaseT Ethernet RJ-45 cables black (PRI Cable)
- ▶ 1 x Printed Flyer

▶ Mediatrix 3742

- ▶ 1 x Mediatrix 3742 unit
- ▶ 1 x power cord for the country in which you are using the Mediatrix 3742
- ▶ 1 x wall/rack mounting kit
- ▶ 1 x Bumpon™ kit for desktop use
- ▶ 1 x 10/100 BaseT Ethernet RJ-45 cable gray
- ▶ 5 x 10/100 BaseT Ethernet RJ-45 cables black (PRI Cable)
- ▶ 1 x Printed Flyer

You may also need additional 10/100 BaseT Ethernet RJ-45 cables.

Location and Mounting Requirements



Warning: The analog lines of the Mediatrix 3700 are not intended for connection to a telecommunication network that uses outside cable.



Warning: To prevent fire or shock hazard do not expose the unit to rain or moisture.

The Mediatrix 3700 is suitable for use in an office environment where it can be placed in the same room or cabinet where the PBX/telephony equipment is located. The unit can be wall-mounted, mounted on a standard 48.26 cm (19 in.) equipment rack, or free standing. In addition, the Mediatrix 3700 can be rack-mounted in a wiring closet or equipment room.

Location

Install the Mediatrix 3700 in a well-ventilated location where it will not be exposed to high temperature or humidity. Do not install the Mediatrix 3700 in a location exposed to direct sunlight or near stoves or radiators. Excessive heat could damage the internal components.

When deciding where to position the Mediatrix 3700, ensure that:

- ▶ The Mediatrix 3700 is accessible for future upgrade, maintenance and troubleshooting, and cables can be easily connected.
- ▶ The cabling is away from the following:
 - Sources of electrical noise such as radios, transmitters, and broadband amplifiers.
 - Power lines and fluorescent lighting fixtures.
 - Water or moisture that could enter the casing of the Mediatrix 3700.
- ▶ The fan on the Mediatrix 3700 is not blocked or that the rear of the unit is not too close to the wall. The unit requires a minimum of 25 mm (1 in.) clearance.
- ▶ The operating temperature is between 0°C and 40°C.
- ▶ The humidity is not over 85% and is non-condensing.

Wiring Requirements

Make sure that the telephone wiring, LAN and WAN cables reach the device and can be dressed in a manner that is safe for the wiring, does not pull or create lateral stress on the connectors on the device, and does not present a trip hazard to personnel working in the vicinity of the equipment. Do not connect any cable or wiring at this time.

Mounting Brackets

The Mediatrix 3700 ships with two brackets for rack-mount installation in a 19-inch rack or wall-mount installation.

Figure 18: Mounting Bracket



Rack-Mounting

Standards Supported

- EIA-310-D
- ETS 300 119

The Mediatrix 3700 fits in most standard 48.26 cm (19 in.) racks. Media5 recommends to use a rack compliant EIA-310-D.

All LEDs located on the front panel are also duplicated on the rear of the Mediatrix 3700, which allows you to rack-mount the unit with the front or the rear facing forwards.

► To rack-mount the Mediatrix 3700:

1. Disconnect all of the cables from the Mediatrix 3700, if applicable.
2. Place the Mediatrix 3700 right side up on a hard flat surface, with the front or rear facing toward you according to the way you want to insert it in the rack.
3. Place one bracket over the mounting holes on the left side of the Mediatrix 3700.
 - For a front facing installation, place the bracket at the front of the unit.
 - For a rear facing installation, place the bracket at the rear of the unit, inverted.
4. Align the bracket with the screw holes and tab hole as illustrated in [Figure 19](#).

Figure 19: Rack-Mounting Installation

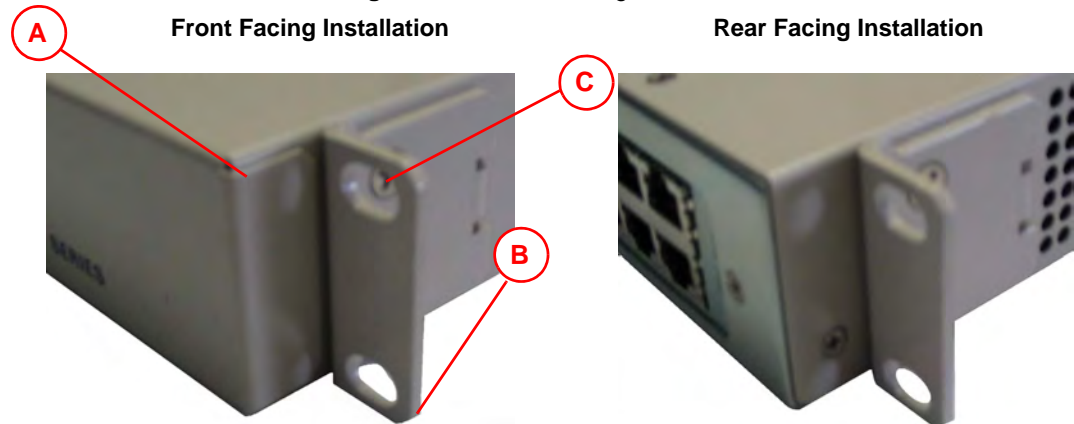

[Table 12](#) describes the mounting pieces you need to rack-mount the Mediatrix 3700.

Table 12: Mounting Pieces

Item	Qty.	Description
A	1	Mediatrix 3700 casing
B	2	Bracket
C	4	18-8 SS Flat Head Philips Machine Screw 8-32 Thread, 5/16" Length

5. Insert the two screws in the mounting bracket, and then tighten.



Note: Use the screws supplied with the mounting brackets. Damage caused to the unit by using incorrect screws invalidates your warranty.

6. Repeat steps 3, 4 and 5 for the other side of the Mediatrix 3700.
7. Insert the Mediatrix 3700 into the rack and secure with suitable screws (not provided). Be sure that the fan is not obstructed.
To prevent bodily injury when mounting or servicing the Mediatrix 3700 in a rack, ensure that the rack remains stable.

The following guidelines are provided to ensure your safety:

- Mount the Mediatrix 3700 at the bottom of the rack if it is the only unit in the rack.
 - When mounting the Mediatrix 3700 in a partially filled rack, load the rack from the bottom to the top with the heaviest component at the bottom of the rack.
 - If the rack is provided with stabilizing devices, install the stabilizers before mounting or servicing the Mediatrix 3700 in the rack.
8. Proceed to [“Hardware Installation” on page 21](#).

Wall-Mounting

You can use the mounting brackets to wall-mount a single Mediatrix 3700.



Caution: You can wall-mount the Mediatrix 3700 with either the right or left side facing up; however, the front and rear panels must be vertical.

► **To wall-mount the Mediatrix 3700:**

1. Disconnect all of the cables from the Mediatrix 3700 before mounting, if applicable.
2. Ensure that the wall you are using is smooth, flat, dry and sturdy. Attach a piece of plywood, approximately 305 mm x 510 mm x 12 mm (12 inches x 20 inches x 0.5 inches) securely to the wall, if necessary.
3. Place the Mediatrix 3700 right side up on a hard flat surface, with the front facing toward you.
4. Place one bracket over the mounting holes on the left side of the Mediatrix 3700 and align the bracket with the screw holes and tab hole as illustrated in [Figure 20](#).

Figure 20: Wall-Mounting Installation

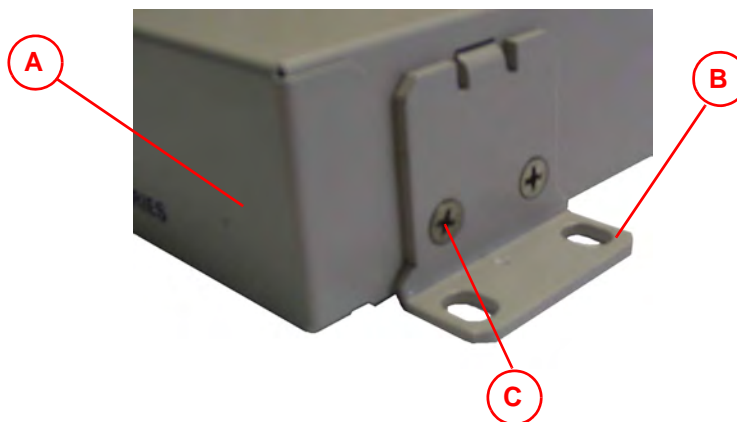

[Table 12](#) describes the mounting pieces you need to wall-mount the Mediatrix 3700.

Table 13: Wall-Mounting Pieces

Item	Qty.	Description
A	1	Mediatrix 3700 casing
B	2	Bracket
C	8	18-8 SS Flat Head Philips Machine Screw 8-32 Thread, 5/16" Length

5. Insert the two screws in the mounting bracket, and then tighten.



Note: Use the screws supplied with the mounting brackets. Damage caused to the unit by using incorrect screws invalidates your warranty.

6. Repeat steps 3 to 5 for the bracket on the other side of the Mediatrix 3700.
Media5 recommends to place the second bracket in the opposite corner to the first bracket for increased stability.
7. Position the Mediatrix 3700 against the wall (or plywood) with the front and rear panels vertical.

Figure 21: Wall-Mount Installation Example

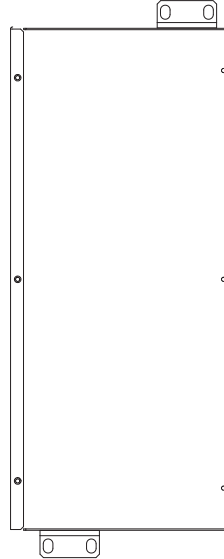

8. Attach the Mediatrix 3700 to the wall (or plywood) with screws (not provided) to ensure that it is secure.
9. Proceed to [“Hardware Installation” on page 21](#).

Free Standing Unit

When installing the Mediatrix 3700 on a desk or table, it should be located at least 20 cm from your monitor, computer casing or other peripherals, including speakers. Never put books or paper on the Mediatrix 3700.

You must also apply the Bumpon™ autoadhesive protective products to the bottom of the Mediatrix 3700. These will stabilize the Mediatrix 3700 and offer skidding resistance.

Condensation

When bringing the unit into a warm environment from the cold, condensation may result that might be harmful to the unit. If this occurs, allow the unit to acclimatize for an hour before powering it on.

Cleaning

To clean the Mediatrix 3700, wipe with a soft dry cloth. Do not use volatile liquids such as benzene and thinner that are harmful to the unit casing.

For resistant markings, wet a cloth with a mild detergent, wring well and then wipe off. Use a dry cloth to dry the surface.

Hardware Installation

This section describes how to set the connectors of the Mediatrix 3700.



Warning: Do not connect the Mediatrix 3700 directly to Telecommunication Systems.



Caution: The Mediatrix 3700 must be installed on a circuit equipped with a breaker so that you can easily power the unit off if required.



Warning: To avoid electrical shock, apply the following instructions:

- The device must be installed by technical personnel.
- Be sure the ground path is connected.

See "[Appendix B - Cabling Considerations](#)" on page 47 for more details on the cables the Mediatrix 3700 uses.

Connecting Cables – Mediatrix 3716

The following describes how to connect the various cables to the Mediatrix 3716.

Figure 22: Mediatrix 3716 Hardware Installation

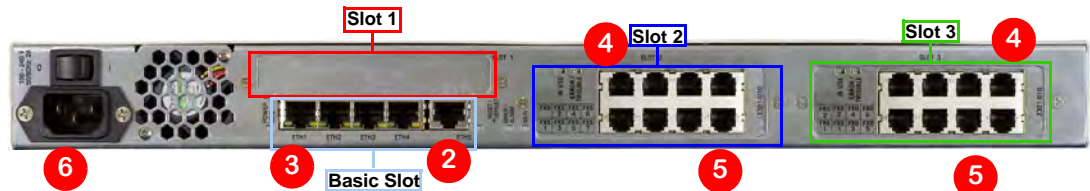

► To install the cables:

1. Before you begin, be sure that the Mediatrix 3716 is powered off.
2. Create a WAN connection by connecting a 10/100 BaseT Ethernet RJ-45 cable into the *ETH5* connector of the Mediatrix 3716.
The other end of the cable is connected to the WAN via a modem or other means.
See "[Ethernet RJ-45 Cable](#)" on page 47 for more details on this cable.
3. If you want to contact the unit via its LAN side, connect a 10/100 BaseT Ethernet RJ-45 cable into either the *ETH1*, *ETH2*, *ETH3*, or *ETH4* connectors of the Mediatrix 3716. Connect the other end to a computer.
See "[Ethernet RJ-45 Cable](#)" on page 47 for more details on this cable.
4. Connect a SCN line into any of the FXO connectors available (optional).
Use a standard telecommunication cord with a minimum of 26 AWG wire size.
5. Connect analog telephones or fax machines into any of the FXS connectors available.
Use a standard telecommunication cord with a minimum of 26 AWG wire size.



Note: The Mediatrix 3716 telephone line interface has been designed to interface with a conventional telephone or fax machine. Connections to FXS ports of third party devices such as a PBX / Key System could damage the Mediatrix 3716.

- Connect the power cord to the Mediatrix 3716 and then connect the other end to an electrical outlet.



Warning: The electrical outlet must be installed near the Mediatrix 3716 so that it is easily accessible.

You are now ready to start the Mediatrix 3716.

Connecting Cables – Mediatrix 3731

The following describes how to connect the various cables to the Mediatrix 3731.

Figure 23: Mediatrix 3731 Hardware Installation

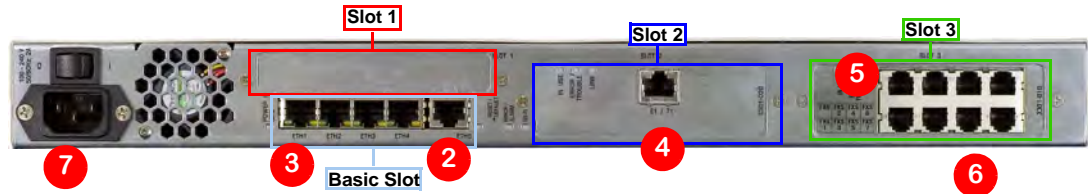

► To install the cables:

- Before you begin, be sure that the Mediatrix 3731 is powered off.
- Create a WAN connection by connecting a 10/100 BaseT Ethernet RJ-45 cable into the *ETH5* connector of the Mediatrix 3731.
The other end of the cable is connected to the WAN via a modem or other means.
See [“Ethernet RJ-45 Cable” on page 47](#) for more details on this cable.
- If you want to contact the unit via its LAN side, connect a 10/100 BaseT Ethernet RJ-45 cable into either the *ETH1*, *ETH2*, *ETH3*, or *ETH4* connectors of the Mediatrix 3731. Connect the other end to a computer.
See [“Ethernet RJ-45 Cable” on page 47](#) for more details on this cable.
- Create an ISDN connection by connecting a T1 or E1 RJ-45 cable into the *E1/T1* connector of Slot 2.
 - If you are using the Mediatrix 3731 with a PBX, connect the other end of the cable to the PBX.
 - If you are using the Mediatrix 3731 with the SCN, connect the other end of the cable to a proper SCN outlet.
- Connect a SCN line into the FXO connector of Slot 3 (optional).
Use a standard telecommunication cord with a minimum of 26 AWG wire size.
- Connect analog telephones or fax machines into the FXS connectors of Slot 3.
Use a standard telecommunication cord with a minimum of 26 AWG wire size.



Note: The Mediatrix 3731 telephone line interface has been designed to interface with a conventional telephone or fax machine. Connections to FXS ports of third party devices such as a PBX / Key System could damage the Mediatrix 3731.

- Connect the power cord to the Mediatrix 3731 and then connect the other end to an electrical outlet.



Warning: The electrical outlet must be installed near the Mediatrix 3731 so that it is easily accessible.

You are now ready to start the Mediatrix 3731.

Connecting Cables – Mediatrix 3732

The following describes how to connect the various cables to the Mediatrix 3732.

Figure 24: Mediatrix 3732 Hardware Installation

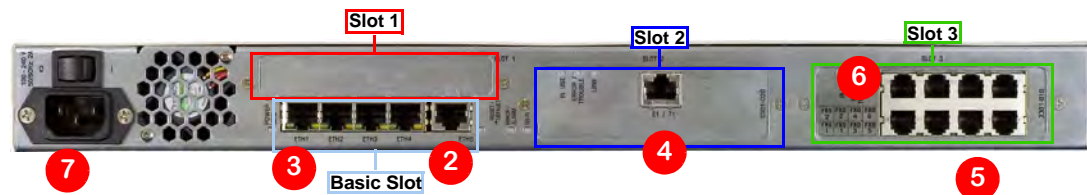

► To install the cables:

1. Before you begin, be sure that the Mediatrix 3732 is powered off.
2. Create a WAN connection by connecting a 10/100 BaseT Ethernet RJ-45 cable into the *ETH5* connector of the Mediatrix 3732.
The other end of the cable is connected to the WAN via a modem or other means.
See [“Ethernet RJ-45 Cable” on page 47](#) for more details on this cable.
3. If you want to contact the unit via its LAN side, connect a 10/100 BaseT Ethernet RJ-45 cable into either the *ETH1*, *ETH2*, *ETH3*, or *ETH4* connectors of the Mediatrix 3732. Connect the other end to a computer.
See [“Ethernet RJ-45 Cable” on page 47](#) for more details on this cable.
4. Create an ISDN connection by connecting a T1 or E1 RJ-45 cable into the *E1/T1* connector of Slot 2.
 - If you are using the Mediatrix 3732 with a PBX, connect the other end of the cable to the PBX.
 - If you are using the Mediatrix 3732 with the SCN, connect the other end of the cable to a proper SCN outlet.
5. Connect a SCN line into the FXO connector of Slot 3 (optional).
Use a standard telecommunication cord with a minimum of 26 AWG wire size.
6. Connect analog telephones or fax machines into the FXS connectors of Slot 3.
Use a standard telecommunication cord with a minimum of 26 AWG wire size.



Note: The Mediatrix 3732 telephone line interface has been designed to interface with a conventional telephone or fax machine. Connections to FXS ports of third party devices such as a PBX / Key System could damage the Mediatrix 3732.

7. Connect the power cord to the Mediatrix 3732 and then connect the other end to an electrical outlet.



Warning: The electrical outlet must be installed near the Mediatrix 3732 so that it is easily accessible.

You are now ready to start the Mediatrix 3732.

Connecting Cables – Mediatrix 3734

The following describes how to connect the various cables to the Mediatrix 3734.

Figure 25: Mediatrix 3734 Hardware Installation

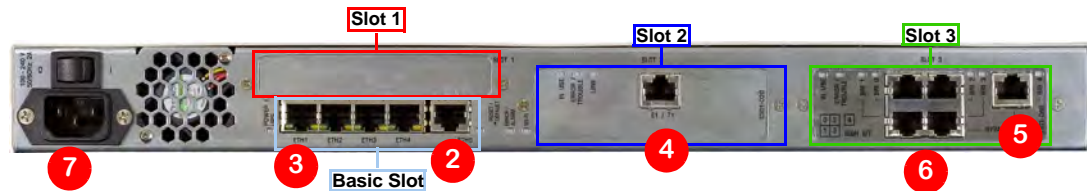

► To install the cables:

1. Before you begin, be sure that the Mediatrix 3734 is powered off.
2. Create a WAN connection by connecting a 10/100 BaseT Ethernet RJ-45 cable into the *ETH5* connector of the Mediatrix 3734.
The other end of the cable is connected to the WAN via a modem or other means.
See [“Ethernet RJ-45 Cable” on page 47](#) for more details on this cable.
3. If you want to contact the unit via its LAN side, connect a 10/100 BaseT Ethernet RJ-45 cable into either the *ETH1*, *ETH2*, *ETH3*, or *ETH4* connectors of the Mediatrix 3734. Connect the other end to a computer.
See [“Ethernet RJ-45 Cable” on page 47](#) for more details on this cable.
4. Create an ISDN connection by connecting a T1 or E1 RJ-45 cable into the *E1 / T1* connector of Slot 2.
 - If you are using the Mediatrix 3734 with a PBX, connect the other end of the cable to the PBX.
 - If you are using the Mediatrix 3734 with the PSTN, connect the other end of the cable to a proper PSTN outlet.
5. Connect a SCN line into either the *BRI 3* or *BRI 4* connectors of Slot 3 (optional).
Use a standard telecommunication cord with a minimum of 26 AWG wire size. Refer to the *Software Configuration Guide* on how to properly configure the ports.
6. Connect BRI RJ-45 cables into any of the BRI connectors of Slot 3.
The other end of the cable is usually connected to a PBX or switch – local exchange (LE).
You must use the following cable types:
 - If the Mediatrix 3734 BRI port is configured in TE mode (USR), use a **straight-through** S-Bus cable with RJ-45 plugs.
 - If the Mediatrix 3734 BRI port is configured in NT mode (NET), use a **crossover** S-Bus cable with RJ-45 plugs.

Refer to the *Software Configuration Guide* for more details on the ports mode and [“BRI RJ-45 Cable” on page 49](#) for more details on the cable to use.

Connect the other end of the cables as follows:

- If you are using the Mediatrix 3734 with a PBX, connect the other end of the cables to the PBX.
- If you are using the Mediatrix 3734 with the SCN, connect the other end of the cables to a proper SCN outlet.
- If you are using the Mediatrix 3734 with ISDN telephones, connect the other end of the cables to ISDN telephones. You must provide an alternate power feeding to the ISDN telephones. This could be by plugging the telephones into a standard electrical outlet or by using an ISDN device that provides power feeding such as an S-bus. This option depends on the type of telephone you are using.

7. Connect the power cord to the Mediatrix 3734 and then connect the other end to an electrical outlet.



Warning: The electrical outlet must be installed near the Mediatrix 3734 so that it is easily accessible.

You are now ready to start the Mediatrix 3734.

Connecting Cables – Mediatrix 3741

The following describes how to connect the various cables to the Mediatrix 3741.

Figure 26: Mediatrix 3741 Hardware Installation

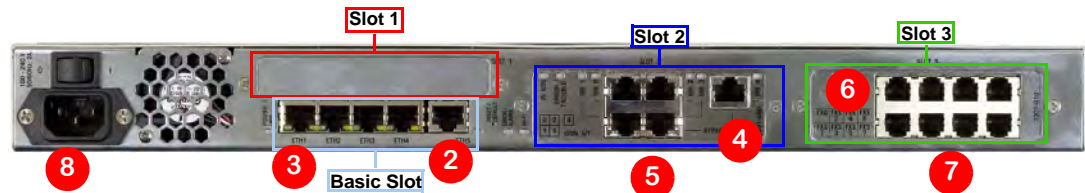

► To install the cables:

1. Before you begin, be sure that the Mediatrix 3741 is powered off.
2. Create a WAN connection by connecting a 10/100 BaseT Ethernet RJ-45 cable into the *ETH5* connector of the Mediatrix 3741.
The other end of the cable is connected to the WAN via a modem or other means.
See [“Ethernet RJ-45 Cable” on page 47](#) for more details on this cable.
3. If you want to contact the unit via its LAN side, connect a 10/100 BaseT Ethernet RJ-45 cable into either the *ETH1*, *ETH2*, *ETH3*, or *ETH4* connectors of the Mediatrix 3741. Connect the other end to a computer.
See [“Ethernet RJ-45 Cable” on page 47](#) for more details on this cable.
4. Connect a SCN line into either the *BRI 3* or *BRI 4* connectors of Slot 2 (optional).
Use a standard telecommunication cord with a minimum of 26 AWG wire size. Refer to the *Software Configuration Guide* on how to properly configure the ports.
5. Connect BRI RJ-45 cables into any of the BRI connectors of Slot 2.
The other end of the cable is usually connected to a PBX or switch – local exchange (LE).
You must use the following cable types:
 - If the Mediatrix 3741 BRI port is configured in TE mode (USR), use a **straight-through** S-Bus cable with RJ-45 plugs.
 - If the Mediatrix 3741 BRI port is configured in NT mode (NET), use a **crossover** S-Bus cable with RJ-45 plugs.

Refer to the *Software Configuration Guide* for more details on the ports mode and [“BRI RJ-45 Cable” on page 49](#) for more details on the cable to use.

Connect the other end of the cables as follows:

- If you are using the Mediatrix 3741 with a PBX, connect the other end of the cables to the PBX.
- If you are using the Mediatrix 3741 with the SCN, connect the other end of the cables to a proper SCN outlet.
- If you are using the Mediatrix 3741 with ISDN telephones, connect the other end of the cables to ISDN telephones. You must provide an alternate power feeding to the ISDN telephones. This could be by plugging the telephones into a standard electrical outlet or by using an ISDN device that provides power feeding such as an S-bus. This option depends on the type of telephone you are using.

6. Connect a SCN line into the FXO connector of Slot 3 (optional).
Use a standard telecommunication cord with a minimum of 26 AWG wire size.
7. Connect analog telephones or fax machines into the FXS connectors of the Slot 3.
Use a standard telecommunication cord with a minimum of 26 AWG wire size.



Note: The Mediatrix 3741 telephone line interface has been designed to interface with a conventional telephone or fax machine. Connections to FXS ports of third party devices such as a PBX / Key System could damage the Mediatrix 3741.

8. Connect the power cord to the Mediatrix 3741 and then connect the other end to an electrical outlet.



Warning: The electrical outlet must be installed near the Mediatrix 3741 so that it is easily accessible.

You are now ready to start the Mediatrix 3741.

Connecting Cables – Mediatrix 3742

The following describes how to connect the various cables to the Mediatrix 3742.

Figure 27: Mediatrix 3742 Hardware Installation

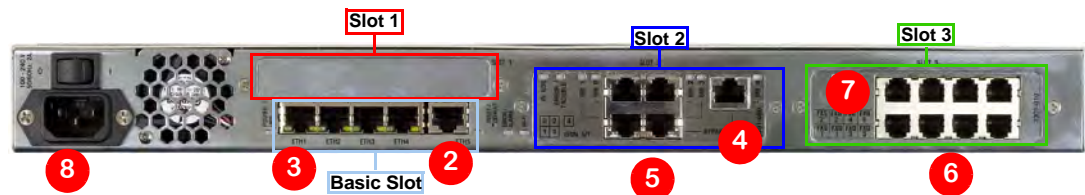

► To install the cables:

1. Before you begin, be sure that the Mediatrix 3742 is powered off.
2. Create a WAN connection by connecting a 10/100 BaseT Ethernet RJ-45 cable into the *ETH5* connector of the Mediatrix 3742.
The other end of the cable is connected to the WAN via a modem or other means.
See [“Ethernet RJ-45 Cable” on page 47](#) for more details on this cable.
3. If you want to contact the unit via its LAN side, connect a 10/100 BaseT Ethernet RJ-45 cable into either the *ETH1*, *ETH2*, *ETH3*, or *ETH4* connectors of the Mediatrix 3742. Connect the other end to a computer.
See [“Ethernet RJ-45 Cable” on page 47](#) for more details on this cable.
4. Connect a SCN line into either the *BRI 3* or *BRI 4* connectors of Slot 2 (optional).
Use a standard telecommunication cord with a minimum of 26 AWG wire size. Refer to the *Software Configuration Guide* on how to properly configure the ports.
5. Connect BRI RJ-45 cables into any of the BRI connectors of Slot 2.
The other end of the cable is usually connected to a PBX or switch – local exchange (LE).
You must use the following cable types:
 - If the Mediatrix 3742 BRI port is configured in TE mode (USR), use a **straight-through** S-Bus cable with RJ-45 plugs.
 - If the Mediatrix 3742 BRI port is configured in NT mode (NET), use a **crossover** S-Bus cable with RJ-45 plugs.

Refer to the *Software Configuration Guide* for more details on the ports mode and [“BRI RJ-45 Cable” on page 49](#) for more details on the cable to use.

Connect the other end of the cables as follows:

- If you are using the Mediatrix 3742 with a PBX, connect the other end of the cables to the PBX.
 - If you are using the Mediatrix 3742 with the SCN, connect the other end of the cables to a proper SCN outlet.
 - If you are using the Mediatrix 3742 with ISDN telephones, connect the other end of the cables to ISDN telephones. You must provide an alternate power feeding to the ISDN telephones. This could be by plugging the telephones into a standard electrical outlet or by using an ISDN device that provides power feeding such as an S-bus. This option depends on the type of telephone you are using.
6. Connect a SCN line into the FXO connector of Slot 3 (optional).
Use a standard telecommunication cord with a minimum of 26 AWG wire size.
 7. Connect analog telephones or fax machines into the FXS connectors of the Slot 3.
Use a standard telecommunication cord with a minimum of 26 AWG wire size.



Note: The Mediatrix 3742 telephone line interface has been designed to interface with a conventional telephone or fax machine. Connections to FXS ports of third party devices such as a PBX / Key System could damage the Mediatrix 3742.

8. Connect the power cord to the Mediatrix 3742 and then connect the other end to an electrical outlet.



Warning: The electrical outlet must be installed near the Mediatrix 3742 so that it is easily accessible.

You are now ready to start the Mediatrix 3742.

This chapter describes the initial provisioning of the Mediatrix 3700.

IP Address Discovery or Configuration

This section describes how to contact the Mediatrix 3700's management interface to start with unit configuration.

Note that the Mediatrix 3700 IPv6 interface is disabled by default.

Once the physical connection is complete and the Mediatrix 3700 is powered up, you must first find out the IP address the Mediatrix 3700 is using. The Mediatrix 3700's WAN IP address can be set either dynamically or statically. The default behaviour of the Mediatrix 3700 is to try to obtain a dynamic IP address through a DHCP server.

You can also access the Mediatrix 3700 through its private LAN interface.

Dynamic WAN IPv4 Address Discovery

The default configuration is set so that the unit can be directly plugged into a network and provisioned with a DHCP server. Media5 strongly recommends to set your DHCP server before installing the unit on the network. This way, you know the WAN IP address associated with a particular unit.



Caution: If you set a Mediatrix 3700 with a static *eth1-4* IPv4 address in a subnet (for instance, 192.168.200.1) and the *eth5* interface receives a dynamic IP address in the same subnet (via a DHCP server or PPP peer), you will not be able to contact the unit via the WAN. You must be careful that a dynamic IP address does not overlap a static IP subnet that is already configured. Note that the current default value of the Mediatrix 3700 is 192.168.0.10.

See the *Software Configuration Guide* for more details on how to set an external DHCP server.



Caution: If you are experiencing problems, or if you do not want to use a DHCP server and use a static IP address instead, perform a Partial Reset procedure, as explained in [“Partial Reset” on page 35](#).

DHCP servers generally allocate a range of IP addresses for use on a network and reserve IP addresses for specific devices using a unique identifier for each device. The Mediatrix 3700 unique identifier is its media access control (MAC) address. You can locate the MAC address as follows:

- ▶ It is printed on the label located on the bottom side of the unit.
- ▶ It is stored in the *System Information* page of the web interface.

If you have not reserved a WAN IP address, you can discover which WAN IP address has been assigned to the Mediatrix 3700 by either:

- ▶ consulting your DHCP server's logs to find out details on the DHCP lease that was given to the Mediatrix 3700.
- ▶ using a network packet sniffer (e.g., Wireshark) to examine the DHCP messages exchanged between the Mediatrix 3700 and your DHCP server while the Mediatrix 3700 boots up.

► **To start the Mediatix 3700 with a dynamic IP address:**

1. If you need to discover the IP address of the Mediatix 3700, install and start your network packet sniffer.
2. Power on the Mediatix 3700 by flipping the power switch. If this is the very first time you are installing the Mediatix 3700, it will restart twice.
3. Power on the PCs.
Your computers do not have to be turned on for the telephone or fax services.
You can now access the Mediatix 3700 web interface. Refer to the *Software Configuration Guide* for more details.

Initial Provisioning Sequence

When starting the Mediatix 3700 for the first time, it needs to be configured before it can support calls. This process is known as *provisioning*. This sequence assumes that you have installed the Mediatix 3700 hardware as per ["Hardware Installation" on page 21](#).

The Mediatix 3700 requests its configuration only on the first restart. You can change the configuration at will after the initial provisioning and the provisioning system can refresh the Mediatix 3700 configuration.

► **Initial provisioning sequence:**

1. When the Mediatix 3700 starts, it broadcasts a message requesting DHCP services (if the unit is configured to start in DHCP mode).
2. The DHCP server responds with a set of WAN IP addresses and network parameters, one of which is the Mediatix 3700 WAN IP address.
The following are some of the network parameters assigned via DHCP:
 - Mediatix 3700 WAN IP address
 - Subnet Mask
 - Default Router IP address
 - DNS IP addresses
 - Configuration script server IP address and port number (optional)
 - SIP Servers IP address and port number
3. The Mediatix 3700 request its configuration by using a configuration file.

Default Static WAN IPv4 Address Configuration

If there is no DHCP server in your network, then the WAN IP address has to be configured statically.

► **To start the Mediatix 3700 with a static WAN IP address:**

1. Power on the Mediatix 3700 by flipping the power switch. If this is the very first time you are installing the Mediatix 3700, it will restart twice.
2. Reconfigure the IP address of your computer to **192.168.0.11** and the Subnet Mask to **255.255.255.0**. Restart the computer.
3. Power on the PCs.
Your computers do not have to be turned on for the telephone or fax services.
4. Insert a small, unbent paper clip into the *RESET/DEFAULT* hole located at the rear of the Mediatix 3700.
The *Power* LED will start blinking, and after a few seconds, all the LEDs will start blinking. Release the paper clip after all the LEDs start blinking and before they all stop blinking (between 7-11 seconds).
This procedure is called a partial reset. After a partial reset is performed, the Mediatix 3700 uses the default WAN IP address 192.168.0.1/24. Refer to ["Partial Reset" on page 35](#) for details on the partial reset procedure.

The corresponding link-local IPv6 address is also available and printed on the sticker under the Mediatrix 3700.

You can now access the Mediatrix 3700 web interface. Refer to the *Software Configuration Guide* for more details.

IPv6 Link Local Address Configuration

If there is no DHCPv6 server or IPv6 router in your network, you can use the link local address to contact the unit. Note that the Mediatrix 3700 IPv6 interface is disabled by default.

1. With a 10/100 Hub and two 10/100 BaseT Ethernet RJ-45 straight cables, connect both cables to the Hub; one of them is connected into the *ETH5* connector. The other cable links the computer to the Hub.
2. Power on the Mediatrix 3700 by connecting the other end of the power cord to an electrical outlet. The electrical outlet must be installed near the Mediatrix 3700 so that it is easily accessible.
3. Insert a small, unbent paper clip into the *RESET/DEFAULT* hole located at the rear of the Mediatrix 3700.

The *Power* LED will start blinking, and after a few seconds, all the LEDs will start blinking. Release the paper clip after all the LEDs start blinking and before they all stop blinking (between 7-11 seconds).

This procedure is called a partial reset. After a partial reset is performed, the Mediatrix 3700 enables its link local IPv6 address. Refer to [“Partial Reset” on page 35](#) for details on the partial reset procedure.

The corresponding link-local IPv6 address is also available and printed on the sticker under the Mediatrix 3700.

4. Proceed with accessing the Mediatrix 3700’s web interface by using the unit’s link local address. The unit’s link local address is printed on a sticker under the unit.

The link local address can be determined by using the following pattern: [fe80::290:f8ff:feXX:XXXX] where XXXXXX are the last 6 digits of the unit’s MAC address. Example: The link local address for the Mediatrix 3700 with MAC address 00:90:F8:12:34:56 would be **[fe80::290:f8ff:fe12:3456]**.



Note: On Windows, a scope ID needs to be added to the link local address ([fe80::290:f8ff:fe12:3456%11]). You can find this number by executing the ‘ipconfig’ command in a command prompt. Note the number at the end of the IPv6 default Gateway for the interface used to contact the unit.

On Linux, the scope identifier may be the link name or the interface number. The interface number can be determined through the Linux command line.

LAN Interface Access

You can access the Mediatrix 3700 via web and SNMP on the unit’s private LAN interface at the address 192.168.0.10. In that case, you must set up your PC to use the private IP address **192.168.0.11**.

1. Power on the Mediatrix 3700 by flipping the power switch. If this is the very first time you are installing the Mediatrix 3700, it will restart twice.

You can now access the Mediatrix 3700 web interface. Refer to the *Software Configuration Guide* for more details.

Vocal Unit Information

When entering special characters on your telephone pad, the Mediatrix 3700 talks back to you with relevant information. This is available only for units with FXS interfaces.

► **To access vocal unit information:**

1. Take one of the telephones connected to the Mediatrix 3700.
2. Dial one of the digits sequence on the keypad.

Table 14: Vocal Unit Information

Digits to Dial	Information Vocally Sent by the Mediatrix 3700
*#*0	Current IP address of the Mediatrix 3700 (static or DHCP).
*#*1	MAC address of the Mediatrix 3700.

Verifying the Installation

There are a few ways to verify that the Mediatrix 3700 is properly connected to the IP network and is working:

- By contacting it with a SNMP browser
- By contacting it via the CLI
- By contacting it via a web browser
- By pinging it

These procedures assume that you know the IP address of the Mediatrix 3700 you want to verify. If the Mediatrix 3700 does not respond, do the following:

- Verify that the LAN and WAN cables are securely connected to the Mediatrix 3700 and to the network connectors.
- Be sure that you did not connect crossover network cables.
- Verify the state of the IP network to ensure it is not down (the *ETH* LED should be ON or blinking).

Indicators (LEDs)

The indicators (LEDs) of the Mediatrix 3700 are described in [“Mediatrix 3700 Connectors and Indicators” on page 2](#).

LED Patterns – Specific Conditions

[Table 15](#) describes the different states a Mediatrix unit can have and their associated LED patterns.

Table 15: LED Patterns

Condition	Description	LED Pattern
RestartPending	Triggered when the <i>RESET/DEFAULT</i> button is pressed in the <i>ResetPending</i> state. The unit prepares for a physical shutdown and restart.	Power LEDs: <ul style="list-style-type: none"> • blinking green, 1Hz, 50% duty All other LEDs: <ul style="list-style-type: none"> • OFF
RecoveryPending	Triggered when the <i>RESET/DEFAULT</i> button is pressed at start-time or for at least 7 seconds.	All LEDs: <ul style="list-style-type: none"> • blinking, 1Hz, 50% duty

Table 15: LED Patterns (Continued)

Condition	Description	LED Pattern
DefaultSettingsPending	Triggered when the <i>RESET/DEFAULT</i> button is not released while in <i>ResetPending</i> state. At run time, if the <i>RESET/DEFAULT</i> button is released within 5 seconds, the unit applies default settings, otherwise the action is cancelled and the unit goes back to the operation mode state or it resets. At start time, the unit stays in this state until the <i>RESET/DEFAULT</i> button is released. The unit then applies the default settings and restarts.	All LEDs: <ul style="list-style-type: none"> steady ON
UpdateInProgress	A firmware pack is downloaded into the unit and written to persistent storage.	All LEDs: <ul style="list-style-type: none"> cycling from left to right, individually blinking 1Hz, 33% duty
UpdateFailed	Triggered after a failure of a firmware pack download operation. After 4 seconds, the unit restarts.	All LEDs: <ul style="list-style-type: none"> blinking at 3Hz, 50% duty. One LED out of two has a 180 degree phase. This pattern lasts for 8 seconds.
Rescue Network Enabled	Triggered after the user has performed a partial reset procedure.	<i>Power</i> and <i>Ready</i> LEDs: <ul style="list-style-type: none"> blinking (synchronized) 1Hz, 75% duty
BootOnRecoveryBank	Triggered when the unit is booting on the recovery bank and no update is pending.	<i>Power</i> LEDs: <ul style="list-style-type: none"> blinking green, 0.25Hz, 75% duty
Automatic network configuration in progress	Waiting for DHCP (IPv4 or IPv6) answer or IPv6 router advertisement or PPPoE connection.	All LEDs: <ul style="list-style-type: none"> Blinking green, 3Hz, 50% duty
No network address set	Triggered when the unit cannot be contacted because DHCP failed, PPP failed, and no static interface is configured.	<i>Power</i> LEDs: <ul style="list-style-type: none"> blinking green, 3 Hz, 50% duty.
NetworkRescue	The unit tries to download and install a firmware given by the Network Rescue server.	<i>Ready</i> LED: <ul style="list-style-type: none"> Off All other LEDs: <ul style="list-style-type: none"> blinking to show a LED displacing light from left to right and right to left.

LED Patterns – Default Behaviour

When no specific condition matches those described in [Table 15](#), the LEDs behave individually according to the following rules:

Table 16: Default LED Behaviour

LED Type ^a	Condition	Behaviour
Power	RestartInProgress	Blinking green, 1 Hz, 50% duty
	RestartCompleted	Steady green
Ethernet	No network traffic, 100 Mbits/s	Steady green
	No network traffic, 10 Mbits/s	Steady orange
	Network traffic, 100 Mbits/s	Blinking green, variable rate
	Network traffic, 10 Mbits/s	Blinking orange, variable rate
In Use	Lines Idle and Unlocked	Off
	Lines InUse and Unlocked	Steady green
	Shutting Down	Steady yellow
	Locked	Blinking yellow, 1 Hz, 50% duty

a. The ERROR/ALARM and ERROR/TROUBLE indicators do not currently have individual behaviours like the other indicators.

RESET/DEFAULT Button

The *RESET/DEFAULT* button allows you to:

- ▶ Cancel an action that was started.
- ▶ Revert to known factory settings if the Mediatix 3700 refuses to work properly for any reason or the connection to the network is lost.
- ▶ Reconfigure a unit.

At Run-Time

The *RESET/DEFAULT* button can be used at run-time – you can press the button while the Mediatix 3700 is running without powering the unit off. [Table 17](#) describes the actions you can perform in this case.

Table 17: RESET/DEFAULT Button Interaction

RESET/DEFAULT Button Pressed for:	Action	Comments	LEDs Pattern
2 to 6 seconds	Restarts the Mediatix 3700	No changes are made to the Mediatix 3700 settings.	<i>Power</i> LEDs: <ul style="list-style-type: none"> • blinking green, 1Hz, 50% duty All other LEDs: <ul style="list-style-type: none"> • OFF
7 to 11 seconds	Sets the Mediatix 3700 in Partial Reset Mode	Sets some of the Mediatix 3700 configuration to pre-determined values.	All LEDs <ul style="list-style-type: none"> • blinking, 1Hz, 50% duty

Table 17: RESET/DEFAULT Button Interaction (Continued)

RESET/DEFAULT Button Pressed for:	Action	Comments	LEDs Pattern
12 to 16 seconds	Restarts the Mediatrix 3700 in Factory Reset	Deletes the persistent configuration, creates a new configuration file with the default factory values, and then restarts the unit.	All LEDs <ul style="list-style-type: none"> steady ON
17 seconds and more	No action is taken	The RESET/DEFAULT Button Pressed event is ignored	N/A

At Start-Time

You can use the *RESET/DEFAULT* button at start-time – you power the unit off, and then depress the button until the LEDs stop blinking and remain ON. This applies the “Factory Reset” procedure (see [“Factory Reset” on page 36](#)). This feature reverts the Mediatrix 3700 back to its default factory settings.

Partial Reset

The Partial reset provides a way to contact the Mediatrix 3700 in a known and static state while keeping most of the configuration unchanged.

Following a partial reset, the Mediatrix 3700 management interface is set to the *Rescue* interface. The default address for this interface is 192.168.0.1/24 and has its corresponding link-local IPv6 available and printed on the sticker under the Mediatrix 3700. Any existing network interface that conflicts with the *Rescue* interface address is disabled.

You can contact the Mediatrix 3700 at this address to access its configuration parameters. It is not advised to access the unit on a regular basis through the *Rescue* network interface. You should reconfigure the unit’s network interfaces as soon as possible in order to access it through another interface. See [“After a Partial Reset” on page 35](#) for more details.

In a partial reset, the following services and parameters are also affected:

- ▶ AAA service: User(s) from profile are restored with their factory password.
- ▶ SNMP service: Resets the *enableSnmpV1*, *enableSnmpV2*, *enableSnmpV3* and *snmpPort* values to their default values.
- ▶ WEB service: Resets the *serverPort* to its default value.

▶ To trigger the Partial Reset:

1. Insert a small, unbent paper clip into the *RESET/DEFAULT* hole located at the rear of the Mediatrix 3700. While pressing the *RESET/DEFAULT* button, restart the unit.
Do not depress before all the LEDs start blinking (between 7-11 seconds).
2. Release the paper clip.

After a Partial Reset

Following a partial reset, you should:

1. Create or activate network interfaces as described in the *Software Configuration Guide*, Chapter *Interface Parameters*, Section *Interfaces Configuration*. Do not disable the *Rescue* interface!
2. Change the Mediatrix 3700 system management network interface to something other than *Rescue* as described in the *Software Configuration Guide*, Chapter *Miscellaneous – Management Interface*, Section *Management Interface Configuration*.

Note that you must be able to contact the interface you select in order to continue with the following steps.

3. Contact the Mediatrix 3700 through the new system management network interface.
4. Disable the *Rescue* network interface as described in the *Software Configuration Guide*, Chapter *Interface Parameters*, Section *Interfaces Configuration*.

Factory Reset

The Factory reset reverts the Mediatrix 3700 back to its default factory settings. It deletes the persistent MIB values of the unit, including:

- ▶ The firmware pack download configuration files.
- ▶ The SNMP configuration, including the SNMPv3 passwords and users.
- ▶ The PPPoE configuration, including the PPP user names and passwords.

The Factory reset creates a new configuration file with the default factory values. It should be performed with the Mediatrix 3700 connected to a network with access to a DHCP server. If the unit cannot find a DHCP server, it sends requests indefinitely.

▶ To trigger the Factory Reset:

1. Power the Mediatrix 3700 off.
2. Insert a small, unbent paper clip into the *RESET/DEFAULT* hole located at the rear of the Mediatrix 3700. While pressing the *RESET/DEFAULT* button, restart the unit.
Do not depress before the LEDs stop blinking and are steadily ON.

3. Release the paper clip.
The Mediatrix 3700 restarts.

This procedure resets all variables in the MIB modules to their default value.

When the Mediatrix 3700 has finished its provisioning sequence, it is ready to be used with a DHCP-provided IP address and MIB parameters.

This procedure can also be performed at run-time.



Note: The Factory reset alters any persistent configuration data of the Mediatrix 3700.

Management Choices

Congratulations for properly installing the Mediatrix 3700. You can now configure the software parameters of the unit.

The Mediatrix 3700 offers various management options. All these options are described in the *Dgw v2.0 Software Configuration Guide*.

Table 18: Management Options

Management Choice	Features
Web GUI	The Mediatrix 3700 web interface allows you to configure the following information: <ul style="list-style-type: none"> • Network attributes • SIP parameters • VoIP settings • Management settings such as configuration scripts, restore / backup, etc.
SNMPv1/2/3	The Mediatrix 3700 SNMP feature allows you to configure all the MIB services.
Command Line Interface (CLI)	The Mediatrix 3700 CLI feature allows you to configure all the MIB services.

Table 18: Management Options (Continued)

Management Choice	Features
Unit Manager Network	The UMN offers the following: <ul style="list-style-type: none"><li data-bbox="651 302 846 331">• Auto-discovery<li data-bbox="651 338 886 367">• Group provisioning<li data-bbox="651 373 1117 403">• SNMP access and remote management.

Standards Compliance and Safety Information

This Appendix lists the various standards compliance of the Mediatrrix 3700.

Standards Supported

The Mediatrrix 3700 complies to the following standards:

Table 19: Standards Compliance

Category	Specification
Agency approvals	<ul style="list-style-type: none"> UL mark European Union, CE mark (Declaration of Conformity) FCC (Mediatrrix 3716/3731/3732/3741/3742)
Safety standards	<ul style="list-style-type: none"> UL60950-1: 2003 1st Edition CAN/CSA-C22.2 No. 60950-1-03 1st Edition April 1, 2003 IEC 60950 (1st Edition 2001 With all national deviations)
Emissions	<ul style="list-style-type: none"> FCC Part 15:2004 Class B EN55022 (2006) Class B (Mediatrrix 3716/3732/3742) EN61000-3-2 (2000) Harmonic current emissions EN61000-3-3 (1995) Voltage fluctuations and flicker (with amendment A1)
Immunity	EN55024:1998 including the following (with amendments A1 and A2): <ul style="list-style-type: none"> EN61000-4-2 (1995), ESD EN61000-4-3 (1996), Radiated RF EN61000-4-4 (1995), Burst Transients EN61000-4-5 (1995), Surge EN61000-4-6 (1996), Conducted RF EN61000-4-11 (1995), Voltage Dips and Interruptions
Telecom	<ul style="list-style-type: none"> FCC Part 68:Subpart D, January 31, 2001 (Mediatrrix 3716/3731/3732/3741/3742) Industry Canada (CS-03, Issue 9, November 15, 2004) (Mediatrrix 3716/3731/3732/3741/3742) TBR 21: January 1998 (Mediatrrix 3716/3731/3732/3741/3742) TBR4:1995 (with amendments A1: 1997) (Mediatrrix 3716/3732/3742)



Note: The standards compliance of the Mediatrrix 3700 are printed on a sticker located on the bottom of the unit.

Disclaimers

The following are the disclaimers related to the Mediatrix 3700.

Federal Communications Commission (FCC) Part 15

This equipment has been tested and found to comply with the limits for a Class B digital device, pursuant to Part 15 of the FCC Rules. These limits are designed to provide reasonable protection against harmful interference in a residential installation. This equipment generates, uses and can radiate radio frequency energy and, if not installed and used in accordance with the instructions, may cause harmful interference to radio communications. However, there is no guarantee that interference will not occur in a particular installation. If this equipment does cause harmful interference to radio or television reception, which can be determined by turning the equipment off and on, the user is encouraged to try to correct the interference by one or more of the following measures:

- ▶ Reorient or relocate the receiving antenna.
- ▶ Increase the separation between the equipment and receiver.
- ▶ Connect the equipment into an outlet on a circuit different from that to which the receiver is connected.
- ▶ Consult the dealer or an experienced radio/TV technician for help



Note: Any changes or modifications not expressly approved by Media5 could void the user's authority to operate the equipment.

Federal Communications Commission (FCC) Part 68



Note: This section applies to the Mediatrix 3716/3731/3732/3741/3742 models.

This equipment complies with Part 68 of the FCC Rules. On the underside of this equipment is a label that contains, among other information, the FCC Registration Number, Ringer Equivalence Number (REN) and USOC jack type for this equipment. You must, upon request, provide this information to your telephone company.

The REN is useful to determine the quantity of devices you may connect to your telephone line and still have all of those devices ring when your telephone number is called. In most, but not all areas, the sum of the REN's of all devices connected to one line should not exceed five (5.0). To be certain of the number of devices you may connect to your line, as determined by the REN, you should contact your telephone company to determine the maximum REN for your calling area. If your telephone equipment causes harm to the telephone network, the Telephone Company may discontinue your service temporarily. If possible, they will notify you in advance, but if advance notice is not practical, you will be notified as soon as possible. You will be informed of your right to file a complaint with the FCC.

Your telephone company may make changes in its facilities, equipment, operations or procedures that could affect the proper functioning of your equipment. If they do, you will be notified in advance to give you an opportunity to maintain uninterrupted telephone service.

If you experience trouble with this telephone equipment, please contact Media5 for information on how to obtain service or repairs. The telephone company may ask that you disconnect this equipment from the network until the problem has been corrected or until you are sure that the equipment is not malfunctioning.

This equipment may not be used on coin service provided by the telephone company.

Connection to party lines is subject to state tariffs.

INSTALLATION

This device is equipped with an USOC RJ-11C connector.

Industry Canada



Note: This section applies to the Mediatrix 3716/3731/3732/3741/3742 models.

This Class B digital apparatus complies with Canadian ICES-003.

Cet appareil numérique de la classe B est conforme à la norme NMB-003 du Canada.

The Industry Canada Label identifies certified equipment. This certification means that the equipment meets telecommunications network protective, operational and safety requirements as prescribed in the appropriate Terminal Equipment Technical Requirements document(s). The Department does not guarantee the equipment will operate to the user's satisfaction.

Before installing this equipment, users should ensure that it is permissible to be connected to the facilities of the local telecommunications company. The equipment must also be installed using an acceptable method of connection. The customer should be aware that compliance with the above conditions may not prevent degradation of service in some situations.

Repairs to certified equipment should be coordinated by a representative designated by the supplier. Any repairs or alterations made by the user to this equipment, or equipment malfunctions, may give the telecommunications company cause to request the user to disconnect the equipment.

Users should ensure for their own protection that the electrical ground connections of the power utility, telephone lines and internal metallic water pipe system, if present, are connected together. This precaution may be particularly important in rural areas.



Warning: Users should not attempt to make such connections themselves, but should contact the appropriate electric inspection authority, or electrician, as appropriate.



Note: The Ringer Equivalence Number (REN) for this terminal equipment is 0.0. The Ringer Equivalence Number (REN) assigned to each terminal device provides an indication of the maximum number of terminals allowed to be connected to a telephone interface. The termination on an interface may consist of any combination of devices subject only to the requirement that the sum of the Ringer Equivalence Number of all the devices does not exceed 5.



Note: This equipment meets the applicable Industry Canada Terminal Equipment Technical Specifications. This is confirmed by the registration number. The abbreviation, IC, before the registration number signifies that registration was performed based on a Declaration of Conformity indicating that Industry Canada technical specifications were met. It does not imply that Industry Canada approved the equipment.

CE Marking



DECLARATION OF CONFORMITY

We Media5 Corporation, located at 4229 Garlock st. Sherbrooke, Québec, Canada J1L 2C8 declare that for the hereinafter mentioned product the presumption of conformity with the applicable essential requirements of DIRECTIVE 1999/5/EC OF THE EUROPEAN

PARLIAMENT (RTTE DIRECTIVE) is given.

Any unauthorized modification of the product voids this declaration.

For a copy of the original signed Declaration Of Conformity please contact Media5 at the above address.

RoHS China

这个文件涉及的是在中华人民共和国境内进口或销售的电子信息产品
Include this document with all Electronic Information Products
imported or sold in the People's Republic of China

部件名称 (Parts)	有毒有害物质或元素 (Hazardous Substance)					
	铅 (Pb)	汞 (Hg)	镉 (Cd)	六价铬 (Cr ⁶⁺)	多溴联苯 (PBB)	多溴二苯醚 (PBDE)
塑料和聚合物部件 (Plastic and Polymeric parts)	○	○	○	○	×	×
集成电路 (Integrated Circuit)	×	○	×	○	×	×
<p>○： 表示该有毒有害物质在该部件所有均质材料中的含量均在 SJ/T-11363 - 2006 规定的限量要求以下。 Indicates that the concentration of the hazardous substance in all homogeneous materials in the parts is below the relevant threshold of the SJ/T-11363 - 2006 standard.</p> <p>×： 表示该有毒有害物质至少在该部件的某一均质材料中的含量可能超出 SJ/T-11363 - 2006 规定的限量要求。 Indicates that the concentration of the hazardous substance of at least one of all homogeneous materials in the parts might exceed the relevant threshold of the SJ/T-11363 - 2006 standard.</p>						

除非另外特别的标注,此标志为针对所涉及产品的环保使用期限标志. 某些可更换的零部件会有一个不同的环保使用期限(例如,电池单元模块)贴在其产品上.

此环保使用期限只适用于产品是在产品手册中所规定的条件下工作.

The Environmentally Friendly Use Period (EFUP) for all enclosed products and their parts are per the symbol shown here, unless otherwise marked. Certain field-replaceable parts have a different EFUP (for example, battery modules) and so are marked to reflect such.

The Environmentally Friendly Use Period is valid only when the product is operated under the conditions defined in the product manual.



Translated Warning Definition

The following information provides an explanation of the symbols which appear on the Mediatrix 3700 and in the documentation for the product.



Warning: Means danger. You are in a situation that could cause bodily injury. Before you work on any equipment, you must be aware of the hazards involved with electrical circuitry and familiar with standard practices for preventing accidents.

Waarschuwing: Dit waarschuwingssymbool betekent gevaar. U overtreedt in een situatie die lichamelijke letsel kan veroorzaken. Voordat u aan enige apparatuur gaat werken, dient u zich bewust te zijn van de bij elektrische schakelingen betrokken risico's en dient u op de hoogte te zijn van standaard maatregelen om ongelukken te voorkomen.

Varoitus: Tämä varoitusmerkki merkitsee vaaraa. Olet tilanteessa, joka voi johtaa ruumiinvammaan. Ennen kuin työskentelet minkään laitteiston parissa, ota selvää sähkökytkentöihin liittyvistä vaaroista ja tavanomaisista onnettomuuksien ehkäisykeinoista.

Attention: Ce symbole d'avertissement indique un danger. Vous vous trouvez dans une situation pouvant causer des blessures ou des dommages corporels. Avant de travailler sur un équipement, soyez conscient des dangers posés par les circuits électriques et familiarisez-vous avec les procédures couramment utilisées pour éviter les accidents.

Warnung: Dieses Warnsymbol bedeutet Gefahr. Sie befinden sich in einer Situation, die zu einer Körperverletzung führen könnte. Bevor Sie mit der Arbeit an irgendeinem Gerät beginnen, seien Sie sich der mit elektrischen Stromkreisen verbundenen Gefahren und der Standardpraktiken zur Vermeidung von Unfällen bewusst.

Avvertenza: Questo simbolo di avvertenza indica un pericolo. La situazione potrebbe causare infortuni alle persone. Prima di lavorare su qualsiasi apparecchiatura, occorre conoscere i pericoli relativi ai circuiti elettrici ed essere al corrente delle pratiche standard per la prevenzione di incidenti.

Advarsel: Dette varselsymbolet betyr fare. Du befinner deg i en situasjon som kan føre til personskade. Før du utfører arbeid på utstyr, må du være oppmerksom på de faremomentene som elektriske kretser innebærer, samt gjøre deg kjent med vanlig praksis når det gjelder å unngå ulykker.

Aviso: Este símbolo de aviso indica perigo. Encontra-se numa situação que lhe poderá causar danos físicos. Antes de começar a trabalhar com qualquer equipamento, familiarize-se com os perigos relacionados com circuitos eléctricos, e com quaisquer práticas comuns que possam prevenir possíveis acidentes.

¡Advertencia! Este símbolo de aviso significa peligro. Existe riesgo para su integridad física. Antes de manipular cualquier equipo, considerar los riesgos que entraña la corriente eléctrica y familiarizarse con los procedimientos estándar de prevención de accidentes.

Warning!: Denna varningssymbol signalerar fara. Du befinner dig i en situation som kan leda till personskada. Innan du utför arbete på någon utrustning måste du vara medveten om farorna med elkretsar och känna till vanligt förfarande för att förebygga skador.

Safety Warnings

This section lists the following safety warnings:

- ▶ Circuit Breaker (15A) Warning
- ▶ TN Power Warning
- ▶ Product Disposal Warning
- ▶ No. 26 AWG Warning
- ▶ LAN and FXS Ports Connectors Warning
- ▶ ISDN BRI Connector Warning
- ▶ Socket Outlet Warning

Circuit Breaker (15A) Warning



Warning: This product relies on the building's installation for short-circuit (overcurrent) protection. Ensure that a fuse or circuit breaker no larger than 120 VAC, 15A U.S. (240 VAC, 10A international) is used on the phase conductors (all current-carrying conductors).

TN Power Warning



Warning: The device is designed to work with TN power systems.

Product Disposal Warning



Warning: Ultimate disposal of this product should be handled according to all national laws and regulations.

No. 26 AWG Warning



Warning: To reduce the risk of fire, use only No. 26 AWG or larger telecommunication line cord.

LAN and FXS Ports Connectors Warning



Warning: Do not connect the LAN and the FXS ports connectors directly to the Public Switched Telephone Network (PSTN), to an off premise application, an out of plant application, any exposed plant application, or to any equipment other than the intended application, connection may result in a safety hazard, and/or defective operation and/or equipment damage.

Exposed plant means where any portion of the circuit is subject to accidental contact with electric lighting or power conductors operating at a voltage exceeding 300V between conductors or is subject to lightning strikes.

ISDN BRI Connector Warning



Warning: Do not connect the ISDN BRI connectors directly to an off premise application, an out of plant application, any exposed plant application, or to any equipment other than the intended application, connection may result in a safety hazard, and/or defective operation and/or equipment damage.

Socket Outlet Warning



Warning: The socket outlet, if used, shall be located near the equipment and shall be easily accessible by the user. The AC adaptor inlet is considered as disconnection device. The device must be readily operational.

Safety Recommendations

To insure general safety follow these guidelines:

- ▶ Do not open or disassemble this product.
- ▶ Do not get this product wet or pour liquids into it.
- ▶ Do not perform any action that creates a potential hazard to people or makes the equipment unsafe.



Caution: When using this equipment, basic safety precautions should always be followed to reduce the risk of fire, electric shock and injury to persons, including the following:

- Do not use this product near water, for example, near a bath tub, wash bowl, kitchen sink or laundry tub, in a wet basement or near a swimming pool.
- Avoid using a telephone (other than a cordless type) during an electrical storm. There may be a remote risk of electric shock from lightning.
- Do not use the telephone to report a gas leak in the vicinity of the leak.

Cabling Considerations

This Appendix describes the pin-to-pin connections for cables used with the Mediatrix 3700.



Warning: To reduce the risk of fire, use only No. 26 AWG or larger telecommunication line cord.

Ethernet RJ-45 Cable

The RJ-45 connector is commonly used for network cabling and for telephony applications. It is used to wire both ends identically so the signals pass straight through.

RJ-45 cabling is also known as Twisted-pair Ethernet (TPE), Unshielded twisted pair (UTP) and 10/100 Base-T.

Figure 28: RJ-45 Cable

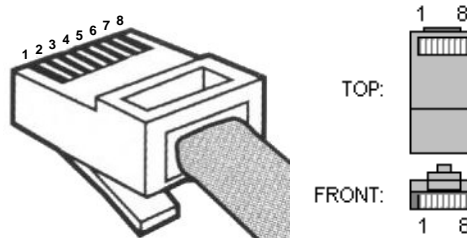

When connecting an Ethernet cable to the Mediatrix 3700, use a standard telecommunication cord with a minimum of 26 AWG wire size. It is possible to use either a crossover or straight Ethernet cable to connect in the Ethernet connectors. These connectors perform automatic MDI / MDIX detection, meaning that they adapt to the type of cable connected to them.

The auto MDI / MDIX feature works only when the connectors are configured in auto detect mode, which is the default mode.

Whenever you force the Mediatrix 3700 to use a specific Ethernet mode (for example 100 Mb Full Duplex), the type of cable to use depends on the other peer. For example, a straight cable is required to connect the Mediatrix 3700 to a hub or a switch, while a crossover cable is required to connect the Mediatrix 3700 to a PC.

Straight Through Cable

A RJ-45 straight through cable is used to connect a computer to a network device. For instance, you must use straight through cables to connect a computer to a network hub, switch, and router.

Table 20: RJ-45 Pinout Information

Pin #	Function	Colour Coding	
		EIA/TIA 568A	EIA/TIA 568B AT&T 258A
1	Transmit +	White with green stripe	White with orange stripe
2	Transmit -	Green with white stripe or solid green	Orange with white stripe or solid orange
3	Receive +	White with orange stripe	White with green stripe
4	N/A	Blue with white stripe or solid blue	Blue with white stripe or solid blue
5	N/A	White with blue stripe	White with blue stripe
6	Receive -	Orange with white stripe or solid orange	Green with white stripe or solid green
7	N/A	White with brown stripe or solid brown	White with brown stripe or solid brown
8	N/A	Brown with white stripe or solid brown	Brown with white stripe or solid brown

The RJ-45 cable uses two pairs of wires: one pair for transmission and the second pair for reception. It is wired so that pins 1 & 2 are on one twisted pair and pins 3 & 6 are on a second pair according to common wiring standards which meet the EIA/TIA T568A and T568B requirements.

Figure 29: Straight Through Connectivity

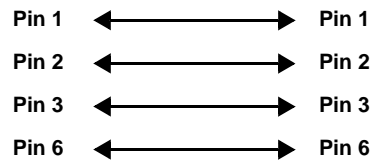

Pin Name and Function

The following is the function of each pin in a RJ-45 cable.

Table 21: Pin Name and Function

Pin #	Name	Function
1	Transmit Data Plus	Positive signal for the TD differential pair. This signal contains the serial output data stream transmitted onto the network.
2	Transmit Data Minus	Negative signal for the TD differential pair. This contains the same output as pin 1.
3	Receive Data Plus	Positive signal for the RD differential pair. This signal contains the serial input data stream received from the network.
4	not connected	
5	not connected	
6	Receive data minus	Negative signal for the RD differential pair. This signal contains the same input as pin 3.
7	not connected	
8	not connected	

Crossover Cable

A RJ-45 crossover cable is used when only two systems are to be connected to each other, peer to peer, at the Ethernet Cards by “crossing over” (reversing) their respective pin contacts. An example would be connecting two computers together to create a network. The crossover eliminates the need for a hub when connecting two computers. A crossover cable may also be required when connecting a hub to a hub, or a transceiver to transceiver or repeater to repeater. When connecting a hub to a transceiver, a straight through cable is always used.



Note: This is not an IEEE supported configuration and should be used for test purposes only.

A crossover cable is sometimes called a null modem. The coloured wires at either end are put into different pin numbers, or crossed over.

Figure 30: Crossover Connectivity

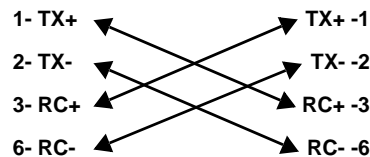

BRI RJ-45 Cable



Caution: The RJ-45 cable you must use with BRI ports is not the same as the RJ-45 cable for the Ethernet connectors, as its pinout is different.

You must use the following cable types:

- ▶ If the Mediatrix 3700 BRI port is configured in TE mode (USR), use a **straight-through** S-Bus cable with RJ-45 plugs.
- ▶ If the Mediatrix 3700 BRI port is configured in NT mode (NET), use a **crossover** S-Bus cable with RJ-45 plugs.

Refer to the *Software Configuration Guide* for more details on the ports mode.



Warning: Hazardous network voltages may be present in the BRI cables. If you detach the cable, detach the end away from the Mediatrix 3700 first to avoid possible electric shock. Network hazardous voltages may be present on the unit in the area of the BRI port, even when power is turned OFF.



Caution: To prevent damage to the Mediatrix 3700, make sure that you connect the BRI cable to the BRI port only and not to any other RJ-45 socket.

Straight Through Cable

Use a RJ-45 straight through cable to connect to a BRI port configured in TE mode.

Table 22: RJ-45 Pinout Information – BRI

Pin #	ISDN BRI Connector Pinout	NT Interface (use straight-through cable)	TE Interface – Default value (use crossover cable)
3	Transmit +	Receive +	Transmit +
4	Receive +	Transmit +	Receive +
5	Receive -	Transmit -	Receive -

Table 22: RJ-45 Pinout Information – BRI (Continued)

Pin #	ISDN BRI Connector Pinout	NT Interface (use straight-through cable)	TE Interface – Default value (use crossover cable)
6	Transmit -	Receive -	Transmit -

Figure 31: Straight Through Connectivity – BRI

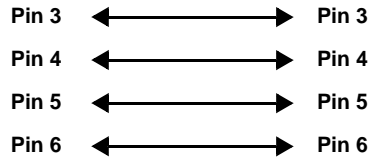

Pin Name and Function

The following is the function of each pin in a RJ-45 cable.

Table 23: Pin Name and Function – BRI

Pin #	Name	Function
1	not connected	
2	not connected	
3	Transmit Data Plus	Positive signal for the TD differential pair. This signal contains the serial output data stream transmitted onto the network.
4	Receive Data Plus	Positive signal for the RD differential pair. This signal contains the serial input data stream received from the network.
5	Receive data minus	Negative signal for the RD differential pair. This signal contains the same input as pin 3.
6	Transmit Data Minus	Negative signal for the TD differential pair. This contains the same output as pin 1.
7	not connected	
8	not connected	

Crossover Cable

Use a RJ-45 crossover cable to connect to a BRI port configured in NT mode (NET).

Figure 32: Crossover Connectivity – BRI

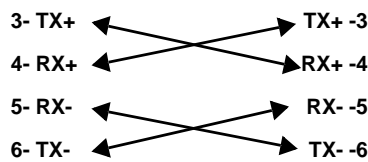

E1 PRI RJ-45 Cable

The E1 PRI is usually connected to a PBX or switch – local exchange (LE). Type and pin outs of these devices vary depending on the manufacturer. The PRI ports pin outs are configurable, so ensure that the appropriate mode (NET or USR) is configured. Refer to the *Software Configuration Guide* for more details.



Warning: Hazardous network voltages may be present in the PRI cables. If you detach the cable, detach the end away from the Mediatrix 3700 first to avoid possible electric shock. Network hazardous voltages may be present on the device in the area of the PRI port, even when power is turned OFF.



Caution: To prevent damage to the Mediatrix 3700, make sure that you connect the PRI cable to the PRI port only and not to any other RJ-45 socket.

The following describes the RJ-45 pinout information.

Table 24: RJ-45 Pinout Information – PRI

Pin #	NT Interface	TE Interface – Default value
1	Transmit #2	Receive #2
2	Transmit #1	Receive #1
4	Receive #2	Transmit #2
5	Receive #1	Transmit #1

Figure 33: RJ-45 Connectivity – PRI

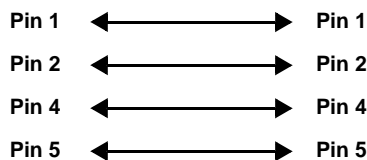

T1 PRI RJ-45 Cable

The T1 PRI is usually connected to a PBX or switch—local exchange (LE). Type and pin outs of these devices vary depending on the manufacturer. The PRI ports pin outs are configurable, so ensure that the appropriate mode (NET or USR) is configured. Refer to the *Software Configuration Guide* for more details.



Warning: Hazardous network voltages may be present in the PRI cables. If you detach the cable, detach the end away from the Mediatrix 3700 first to avoid possible electric shock. Network hazardous voltages may be present on the device in the area of the PRI port, even when power is turned OFF.



Caution: To prevent damage to the Mediatrix 3700, make sure that you connect the PRI cable to the PRI port only and not to any other RJ-45 socket.

The following describes the RJ-45 pinout information.

Table 25: RJ-45 Pinout Information – PRI

Pin #	NT Interface	TE Interface – Default value
1	Transmit #2	Receive #2

Table 25: RJ-45 Pinout Information – PRI (Continued)

Pin #	NT Interface	TE Interface – Default value
2	Transmit #1	Receive #1
4	Receive #2	Transmit #2
5	Receive #1	Transmit #1

Figure 34: RJ-45 Connectivity – PRI

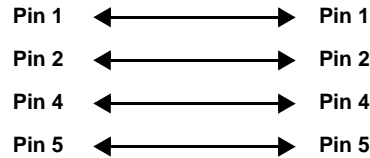

RJ-11 (Telephone) Cable

The RJ-11 cable is commonly used for telephone connection.



Caution: Do not plug a phone jack connector into an RJ-45 port.

Wiring Conventions

For telephone connections, a cable requires one pair of wires. Each wire is identified by different colours. For instance, one wire might be red and the other, red with white stripes. Also, an RJ-11 connector must be attached to both ends of the cable.

Each wire pair must be attached to the RJ-11 connectors in a specific orientation. The following figure illustrates how the pins on the RJ-11 connector are numbered. Be sure to hold the connectors in the same orientation when attaching the wires to the pins.

Figure 35: RJ-11 Connector Pin Numbers

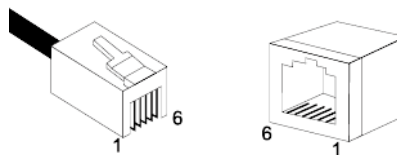

Table 26: RJ-11 Pinout Information

Pin #	Function
1	Not used
2	Not used
3	Ring
4	Tip
5	Not used
6	Not used

The RJ-11 pair of wires is wired so that pins 3 and 4 are connected to the Ring and Tip, which meets the following requirements:

- ▶ EIA/TIA-IS 968
- ▶ CS-03 Issue 8, Part III requirements.



Warning: The RJ-11 cable should comply with UL 1863 and CSA C22.2 No 233 standards.

Serial Console (RS-232)

DTE or DCE

A device that communicates over a synchronous serial interface is either a DTE (Data Terminal Equipment) or DCE (Data Communications Equipment) device. DTE devices usually connect to DCE devices. The Mediatrix 3700 and a PC are a DTE, while a CLI terminal is a DCE.

Crossover Cable (Null Modem)

The crossover version of the DB-9 cable (also known as null modem) uses a female-to-female cable in any application where you wish to connect the Mediatrix 3700 with another DTE device such as a PC or workstation. This cable is required for CLI application.

The purpose of a null-modem cable is to permit two RS-232 "DTE" devices to communicate with each other without modems or other communication devices (i.e., DCEs) between them.

To achieve this, the most obvious connection is that the TD signal of one device must be connected to the RD input of the other device (and vice versa).

Figure 36: DB-9 Crossover Connectivity

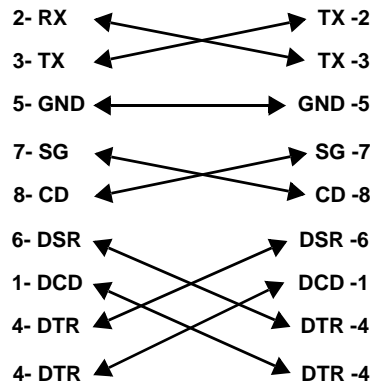



Standard Hardware Information

The specifications and information regarding this product are subject to change without notice. Every effort is made to ensure the accuracy of this document. Because of ongoing product improvements and revisions, Media5 cannot guarantee its accuracy, nor can be responsible for errors or omissions. Please contact your Media5 sales representative to obtain the latest version of the technical specifications.

Industry Standard Protocols

The Mediatrix 3700 has been designed to support all major industry standards used today, as well as those that will eventually be implemented at a later date. Because of this specific design characteristic, the Mediatrix 3700 can be integrated with existing telephone, fax and data equipment such as PCs and routers.

Table 27: Industry Standard Protocols

Parameter	Description
Vocoders	<ul style="list-style-type: none"> • G.711 (a-law, u-law) with optional VAD support • G.723.1a • G.726 • G.729a • G.729ab
IP Telephony Protocols	<ul style="list-style-type: none"> • SIP - RFC 3261, RFC 3262, RFC 3263
Real-Time Transport Protocols	<ul style="list-style-type: none"> • RTP/RTCP - RFC 1889, RFC 1890, RFC 2833, RFC 3389
Network Management Protocols	<ul style="list-style-type: none"> • SNMPv3 • DHCP - RFC 2131, RFC 2132 • TFTP - RFC 1350 • Syslog - RFC 3164 • HTTP 1.0 - RFC 1945 • HTTP 1.1 - RFC 2616 • HTTPS • Basic and digest HTTP authentication - RFC 2617
Data Features	<ul style="list-style-type: none"> • PPPoE client - RFC 1332, RFC 1661, RFC 1334, RFC 1994, RFC 2516, RFC 1471, RFC 1472, RFC 1473, RFC 1877. Note: some PPPoE RFCs are implemented partially. • TFTP or HTTP auto-provisioning • DHCP server • NAT
QoS	<ul style="list-style-type: none"> • ToS • DiffServ • 802.1p • 802.1Q

Table 27: Industry Standard Protocols (Continued)

Parameter	Description
Voice Signalling	<ul style="list-style-type: none"> • Euro ISDN EDSS-1 / ETSI PRI/NET5^a • Euro ISDN EDSS-1 / ETSI BRI/NET3^b • ETS 300 012-1 (ITU-T I.430) • ETS 300 402-2 (ITU-T Q.921) • ETS 300 403-1/2 (ITU-T Q.931) • ETS 300 102-2 (ITU-T Q.931) • ETS 300 402-1 (ITU-T Q.921) • ETS 300 403-2 (ITU-T Q.931) • ETS 300 102-1 (ITU-T Q.931) • ISDN speech, audio and data (Fax Gr 4, UDI 64, RDI 64) • ECMA-143 (QSIG-BC)

a. Mediatrix 3731 / 3732 / 3734 models (PRI interface)

b. Mediatrix 3741 / 3742 models (BRI interface)

Hardware Features

Interfaces

Mediatrix 3716

- ▶ 1 x RJ-45 WAN connector, 10/100 BaseT Ethernet access
- ▶ 4 x RJ-45 LAN connectors, 10/100 BaseT Ethernet access
- ▶ 9 x RJ-11 connectors, analog phone/fax (FXS) interface.
- ▶ 7 x RJ-11 connectors, analog line (FXO) interface.

Mediatrix 3731

- ▶ 1 x RJ-45 WAN connector, 10/100 BaseT Ethernet access
- ▶ 4 x RJ-45 LAN connectors, 10/100 BaseT Ethernet access
- ▶ 1 x ISDN PRI ports software configurable as NT or TE
- ▶ 7 x RJ-11 connectors, analog phone/fax (FXS) interface.
- ▶ 1 x RJ-11 connector, analog line (FXO) interface.

Mediatrix 3732

- ▶ 1 x RJ-45 WAN connector, 10/100 BaseT Ethernet access
- ▶ 4 x RJ-45 LAN connectors, 10/100 BaseT Ethernet access
- ▶ 1 x ISDN PRI ports software configurable as NT or TE
- ▶ 2 x RJ-11 connectors, analog phone/fax (FXS) interface.
- ▶ 6 x RJ-11 connectors, analog line (FXO) interface.

Mediatrix 3734

- ▶ 1 x RJ-45 WAN connector, 10/100 BaseT Ethernet access
- ▶ 4 x RJ-45 LAN connectors, 10/100 BaseT Ethernet access

- ▶ 5 x ISDN BRI ports software configurable as NT or TE per card
- ▶ 1 x ISDN PRI ports software configurable as NT or TE
- ▶ Configurable point-to-point, point-to-multipoint and connector pinout
- ▶ Cut-through relay for emergency operation (bypass connection)

Mediatix 3741

- ▶ 1 x RJ-45 WAN connector, 10/100 BaseT Ethernet access
- ▶ 4 x RJ-45 LAN connectors, 10/100 BaseT Ethernet access
- ▶ 5 x ISDN BRI ports software configurable as NT or TE per card
- ▶ 7 x RJ-11 connectors, analog phone/fax (FXS) interface.
- ▶ 1 x RJ-11 connector, analog line (FXO) interface.
- ▶ Configurable point-to-point, point-to-multipoint and connector pinout
- ▶ Cut-through relay for emergency operation (bypass connection)

Mediatix 3742

- ▶ 1 x RJ-45 WAN connector, 10/100 BaseT Ethernet access
- ▶ 4 x RJ-45 LAN connectors, 10/100 BaseT Ethernet access
- ▶ 5 x ISDN BRI ports software configurable as NT or TE per card
- ▶ 2 x RJ-11 connectors, analog phone/fax (FXS) interface.
- ▶ 6 x RJ-11 connectors, analog line (FXO) interface.
- ▶ Configurable point-to-point, point-to-multipoint and connector pinout
- ▶ Cut-through relay for emergency operation (bypass connection)

Power

- ▶ AC: Standard power cord receptacle (IEC 320 – C14) for universal AC input internal SMPS.

Product Architecture Details

- ▶ Supports multiple concurrent communications using any vocoders.
- ▶ DSP-based DTMF detection and generation.
- ▶ DSP-based fax relay.
- ▶ Embedded IPv4 TCP/IP stack with configurable QoS implemented by:
 - ToS byte at Network layer 3
 - 802.1p at Data Link layer 2
- ▶ Network parameters assigned via DHCP

Real Time Fax Router Technical Specifications

Automatic selection between voice and fax.

Table 28: Fax Technical Specifications

Parameter	Description
Ethernet	10/100 BaseT Ethernet
Data Link	Ethernet

Table 28: Fax Technical Specifications (Continued)

Parameter	Description
Network	IP (Internet Protocol)
Transport	TCP / UDP
Protocols	Group 3 Fax Clear channel (G.711) or T.38 Real Time Fax Over IP protocol Stack
Fax Data Compression	MH
Fax Transmission	Up to 14.4 kbps

Analog Line Interface (FXS)



Note: This section applies to the Mediatix 3716/3731/3732/3741/3742 models.

- ▶ RJ-11 connectors
- ▶ Direct connection to a fax machine or telephone (Internal installation and internal cabling)
- ▶ DC feeding of the access line protected for over voltage
- ▶ Loop current detection and hook flash detection capable
- ▶ Generation of Selective Ring

Table 29: Analog Line Interface

Parameter	Description
Trunk Type	Loop Start
Ring Source	45 VRMS max @ 20 up to 50 Hz (selectable) sine signal
Nominal Impedance	BellCore compliant 600/900 ohms default setting.
Ring Drive Capacity	Up to 4 ringer equivalents (4 RENs) per port.
Loop Current Range	15 to 32 ma factory set. Default 20 ma regulated.
Ring Trip Detection Time	2 ring cycles max
On Hook Voltage	-48 VDC
Frequency Response	200 Hz to 3400 Hz ± 3 dB (Tx/Rx)
Return Loss	600-3400 Hz: 30 dB

PSTN Interface (FXO)



Note: This section applies to the Mediatix 3716/3731/3732/3741/3742 models.

- ▶ Programmable line interface
- ▶ Programmable loss plan
- ▶ Built-in transient/surge protection
- ▶ RJ-11 connectors

- ▶ Detection of Selective Ring

Table 30: FXO Interface

Parameter	Description
Trunk Type	Loop Start/
Ring Detection	22 VRMS min, 15 Hz to 68 Hz (configurable by parameter)
Nominal Impedance	AC and DC impedance software configurable to support most countries worldwide.
Ringer Equivalence	0.1 REN

Audio Specifications

- ▶ Software-adjustable dynamic and static jitter buffer protection.
- ▶ Programmable by country: Call progress tone generation including dial tone, busy tone, ringback and error tones.
- ▶ Silence detection/suppression level software adjustable.

DTMF Tone Detection

Table 31: DTMF Tone Detection

Parameter	Description
16-Digit DTMF Decoding	0 to 9, *, #, A, B, C, D
Permitted Amplitude Tilt	High frequency can be +2 dB to -8 dB relative to low frequency
Dynamic Range	-35 dBm to +3 dBm per tone
Frequency Accept	$\pm 1.5\%$ of nominal frequencies
Minimum Tone Duration	40 ms
Interdigit Timing	Detects like digits with a 40 ms interdigit delay

DTMF Tone Generation

Table 32: DTMF Tone Generation

Parameter	Description
Per Frequency Nominal	-6 dBm to -4 dBm
Frequency Deviation	Less than 1%

Power Consumption

Table 33: Power Consumption

Mediatrix Model	Voltage/ Frequency	Operating Condition	Current (mA)	Power (W)	VA	Thermal Dissipation (W)
3731	120Vac / 60Hz	TBD	TBD	TBD	TBD	TBD
	240Vac / 50Hz	TBD	TBD	TBD	TBD	TBD
3732	120Vac / 60Hz	TBD	TBD	TBD	TBD	TBD
	240Vac / 50Hz	TBD	TBD	TBD	TBD	TBD
3734	120Vac / 60Hz	TBD	TBD	TBD	TBD	TBD
	240Vac / 50Hz	TBD	TBD	TBD	TBD	TBD
3741	120Vac / 60Hz	TBD	TBD	TBD	TBD	TBD
	240Vac / 50Hz	TBD	TBD	TBD	TBD	TBD
3742	120Vac / 60Hz	TBD	TBD	TBD	TBD	TBD
	240Vac / 50Hz	TBD	TBD	TBD	TBD	TBD

MTBF Value

The Mean Time Before Failure (MTBF) value of the Mediatrix 3700 models is estimated as follows:

- ▶ Mediatrix 3716: TBD
- ▶ Mediatrix 3731: TBD
- ▶ Mediatrix 3732: TBD
- ▶ Mediatrix 3734: TBD
- ▶ Mediatrix 3741: TBD
- ▶ Mediatrix 3742: TBD

These values are at 25 degrees Celsius ambient temperature. It has been defined using RelCalc v5.0, Bellcore method (LimitedStress - Method I, Case 3), Desktop unit .

Operating Environment

Table 34: Operating Environment

Parameter	Description
Operating Temperature	0°C to 40°C
Humidity	Up to 85%, non-condensing
Storage	-20°C to +70°C

Dimensions and Weight

Table 35: Dimensions and Weight

Parameter	Description
Dimensions	Height: 4.4 cm (1.73 in) Width, no mounting brackets: 44.5 cm (17.5 in) Width, with mounting brackets: 48.5 cm (19 in) Depth: 20.5 cm (8 in)
Weight	3.0 kg (6.6 lb)

Warranty

All Media5 products carry Media5 Corporation's standard three-year hardware and software warranty. An extended warranty is available.

Interface Card Installation Instructions

This Appendix describes how to install interface cards in a Mediatrix 3700 unit.

General Information

This assembly instruction is generic to any model of interface card.

- ▶ Some of the steps are optional, depending on the model to be assembled.
- ▶ The pictures shown in this Appendix are for reference only.
- ▶ The specification of the screws used in this assembly instruction are:
 - 615-00023-00G: Screw #4-40 3/16" Flat Head Phillips 70% Undercut Stainless Steel
 - 615-00039-00G: Screw #4-40 1/4" Pan head Phillips Stainless steel internal lock SEMS

Interface Card Installation Instructions

Follow these instructions with care.

1. Remove ALL cables connected to the unit prior to start working.
The Mediatrix 3700 series has internal AC/DC power supply and telephony interfaces with hazardous sections accessible when the cover is removed. It is imperative for your own safety to remove all cables connected to the unit prior to start working.
2. Remove the screws of the ear mounting brackets on each side of the unit (keep them for re-assembly of the casing).
3. Remove all the screws of the top casing.
There are three screws located on the top side, three screws located on the bottom side, and one screw located on each side (keep them for re-assembly of the casing).
4. Slide the top casing to remove it from the unit.
5. Remove the screws of the "SLOT2" and/or "SLOT3" plate where you want to install the new card (keep them for re-assembly of the casing).



Note: When installing a mix of digital interface card and analog interface card, ALWAYS install the digital interface card in "SLOT2".

- Align the 4x21 pins header connector of the card to the receptacle on the motherboard. Make sure that the card header is well inserted onto its mating receptacle.



Note: Special note for the interface card 3301-080 (2FXS/6FXO card): Bend slightly the capacitors on the motherboard in order to allow adequate installation of the card. Latest Motherboard assemblies have a low height capacitor model to resolve this known issue.

Figure 37: Bending of Capacitor

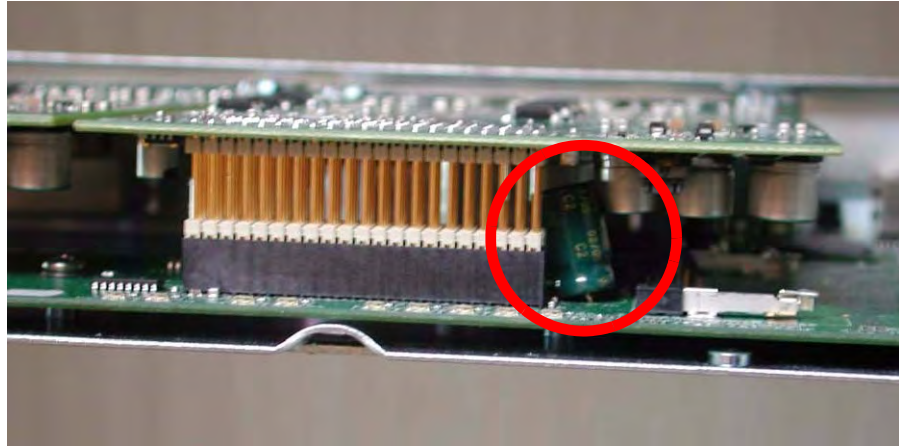

- Screw the interface card's plate with the 615-00023-00G screws (torque: 3 inch pounds).

Figure 38: Screw Interface Card's Plate



- Screw the center of the plate with 615-00039-00G model (torque: 3 inch pounds).

Figure 39: Screw Center of Plate



- Slide-in the top cover all the way to the end. Make sure that the RS-232 connector does not interfere with its opening on the top cover.

10. Screw the top casing at all 8 locations (torque: 3 inch pounds).
There are three screws located on the top side, three screws located on the bottom side, and one screw located on each side.
11. Install the ear mounting brackets and screw them in place (torque: 4 inch pounds).
12. Make sure there is no sound/rattle coming from the unit when manipulated (loose part).
13. Apply the card serial number label next to the base unit label.

Figure 40: Applying the Card Serial Number Label



14. Reconnect the power and telephony cables.
15. Upgrade the unit firmware if necessary.



Note: Special note for the interface card 3301-080 (2FXS/6FXO card): Use Firmware DGW v2.0r8.111 or higher.

10 BaseT

An Ethernet local area network that works on twisted pair wiring.

100 BaseT

A newer version of Ethernet that operates at 10 times the speed of a 10 BaseT Ethernet.

Basic Rate Interface (BRI)

An Integrated Services Digital Network configuration defined in the physical layer standard I.430 produced by the ITU. This configuration consists of two 64 kbit/s “bearer” channels (B channels) and one 16 kbit/s “data” channel (D channel). The B channels are used for voice or user data, and the D channel is used for any combination of: data, control/signalling and X.25 packet networking. The two B channels can be bonded together giving a total data rate of 128 kbit/s. BRI is the kind of ISDN interface most likely to be found in residential service.

Domain Name Server (DNS)

Internet service that translates domain names into IP addresses. To use a domain name, a DNS service must translate the name into the corresponding IP address. For instance, the domain name *www.example.com* might translate to 198.105.232.4.

Dual-Tone Multi-Frequency (DTMF)

In telephone systems, multi-frequency signalling in which a standard set combinations of two specific voice band frequencies, one from a group of four low frequencies and the other from a group of four higher frequencies, are used. Although some military telephones have 16 keys, telephones using DTMF usually have 12 keys. Each key corresponds to a different pair of frequencies. Each pair of frequencies corresponds to one of the ten decimal digits, or to the symbol “#” or “*”, the “*” being reserved for special purposes.

Dynamic Host Configuration Protocol (DHCP)

TCP/IP protocol that enables PCs and workstations to get temporary or permanent IP addresses (out of a pool) from centrally-administered servers.

Federal Communications Commission (FCC)

U.S. government regulatory body for radio, television, interstate telecommunications services, and international services originating in the United States.

Foreign Exchange Service/Station (FXS)

A network-provided service in which a telephone in a given local exchange area is connected, via a private line, to a central office in another, i.e., “foreign”, exchange, rather than the local exchange area’s central office. This is the station (telephone) end of an FX circuit. An FXS port will provide dial tone and ring voltage.

Gateway

A device linking two different types of networks that use different protocols (for example, between the packet network and the Public Switched Telephone Network).

Integrated Services Digital Network (ISDN)

A set of digital transmission protocols defined by the international standards body for telecommunications, the ITU-T (formerly called the CCITT). These protocols are accepted as standards by virtually every telecommunications carrier all over the world.

ISDN complements the traditional telephone system so that a single pair of telephone wires is capable of carrying voice and data simultaneously. It is a fully digital network where all devices and applications present themselves in a digital form.

International Telecommunication Union (ITU)

Organization based in Geneva, Switzerland, that is the most important telecom standards-setting body in the world.

Internet Protocol (IP)

A standard describing software that keeps track of the Internet's addresses for different nodes, routes outgoing messages, and recognizes incoming messages.

Light Emitting Diode (LED)

A semiconductor diode that emits light when a current is passed through it.

Local Area Network (LAN)

Data-only communications network confined to a limited geographic area, with moderate to high data rates. See also WAN.

Media Access Control (MAC) Address

A layer 2 address, 6 bytes long, associated with a particular network device; used to identify devices in a network; also called hardware or physical address.

Network

A group of computers, terminals, and other devices and the hardware and software that enable them to exchange data and share resources over short or long distances. A network can consist of any combination of local area networks (LAN) or wide area networks (WAN).

Primary Rate Interface (PRI)

A telecommunications standard for carrying multiple DS0 voice and data transmissions between two physical locations. All data and voice channels are (ISDN) and operate at 64 kbit/s.

North America and Japan use a T1 of 23 B channels and one D channel which corresponds to a T1 line. Europe, Australia and most of the rest of the world use the slightly higher capacity E1, which is composed of 31 B channels and one D channel.

Fewer active B channels (also called user channels) can be used for a fractional T1. More channels can be used with more T1's, or with a fractional or full T3 or E3.

Private Branch Exchange (PBX)

A small to medium sized telephone system and switch that provides communications between onsite telephones and exterior communications networks.

Protocol

A formal set of rules developed by international standards bodies, LAN equipment vendors, or groups governing the format, control, and timing of network communications. A set of conventions dealing with transmissions between two systems. Typically defines how to implement a group of services in one or two layers of the OSI reference model. Protocols can describe low-level details of machine-to-machine interfaces or high-level exchanges between allocation programs.

Public Switched Telephone Network (PSTN)

The local telephone company network that carries voice data over analog telephone lines.

Router

A specialized switching device which allows customers to link different geographically dispersed local area networks and computer systems. This is achieved even though it encompasses different types of traffic under different protocols, creating a single, more efficient, enterprise-wide network.

Switched Circuit Network (SCN)

A communication network, such as the public switched telephone network (PSTN), in which any user may be connected to any other user through the use of message, circuit, or packet switching and control devices.

Server

A computer or device on a network that works in conjunction with a client to perform some operation.

Session Initiation Protocol (SIP)

A protocol for transporting call setup, routing, authentication, and other feature messages to endpoints within the IP domain, whether those messages originate from outside the IP cloud over SCN resources or within the cloud.

Subnet

An efficient means of splitting packets into two fields to separate packets for local destinations from packets for remote destinations in TCP/IP networks.

Transmission Control Protocol/Internet Protocol (TCP/IP)

The basic communication language or protocol of the Internet. It can also be used as a communications protocol in a private network (either an intranet or an extranet).

Voice Over IP (VoIP)

The technology used to transmit voice conversations over a data network using the Internet Protocol. Such data network may be the Internet or a corporate Intranet.

Wide Area Network (WAN)

A large (geographically dispersed) network, usually constructed with serial lines, that covers a large geographic area. A WAN connects LANs using transmission lines provided by a common carrier.

List of Acronyms

AWG	American Wire Gauge
BRI	Basic Rate Interface
CE	Cummunauté européenne (French)
dB	Decibel
DCE	Data Communications Equipment
DHCP	Dynamic Host Configuration Protocol
DNS	Domain Name Server
DTE	Data Terminal Equipment
ESD	Electrostatic Discharge
ETSI	European Telecommunications Standards Institute
FCC	Federal Communications Commission (USA)
FXO	Foreign Exchange Office
FXS	Foreign Exchange Service/Station
Hz	Hertz
IETF	Internet Engineering Task Force
LED	Light Emitting Diode
ma	milliampere
MAC	Media Access Control
MDI	Media Dependent Interface
MDIX	Media Dependent Interface Crossover
PBX	Private Branch eXchange
PRI	Primary Rate Interface
PSTN	Public Switched Telephone Network
REN	Ringer Equivalence Number
RFC	Request for Comment
SCN	Switched Circuit Network
SIP	Session Initiation Protocol
TPE	Twisted-Pair Ethernet
UL	Underwriters Laboratories Incorporated
USB	Universal Serial Bus
UTP	Unshielded Twisted pair
VAC	Volts Alternating Current
VoIP	Voice over Internet Protocol
WAN	Wide Area Network

Index

Numerics

- 10 BaseT [4](#), [6](#), [7](#), [21](#), [22](#), [23](#), [24](#), [25](#), [26](#), [47](#)
 - defined [67](#)
 - see also *cabling*
- 100 BaseT [4](#), [6](#), [7](#), [21](#), [22](#), [23](#), [24](#), [25](#), [26](#), [47](#)
 - defined [67](#)
 - see also *cabling*

A

- acronyms [71](#)
- audience, intended [viii](#)
- auto MDI/MDIX [47](#)

B

- Bypass connection, connecting [21](#), [22](#), [23](#), [24](#), [25](#), [26](#), [27](#)
- Bypass connection, in BRI [12](#)

C

- cables, connecting [21](#)
- cabling
 - RJ-11 [52](#)
 - RJ-45
 - crossover [49](#)
 - crossover, BRI [50](#)
 - pin name [48](#)
 - pin name, BRI [50](#)
 - pinout information [48](#)
 - pinout information, BRI [49](#)
 - straight through [48](#)
 - straight through, BRI [49](#)
 - RS-232
 - crossover [53](#)
 - pinout information (straight through) [53](#)
 - see also *10 BaseT*
 - see also *100 BaseT*
- cleaning the unit [20](#)
- compliance to standards. see *standards compliance*
- condensation [20](#)
- connecting
 - cables during installation [21](#), [22](#), [23](#), [24](#), [25](#), [26](#)
 - unit [21](#)
- connectors
 - Ethernet [6](#)
 - front [3](#)
 - FXO line [9](#)
 - FXS lines [8](#), [9](#)
 - port numbering convention
 - BRI [11](#)
 - Ethernet [10](#)
 - FXS/FXO [11](#)
 - PRI [10](#)
 - power [6](#)
 - rear [4](#)
 - reset default [6](#)
- crossover cable. see *cabling*
- customer services [xi](#)

D

- document
 - conventions [ix](#)
 - objectives [vii](#)
 - structure [viii](#)
- documentation
 - Media5 download portal [x](#)
 - Mediatrix download portal [x](#)
 - where to obtain [x](#)

E

- end user technical support [xi](#)
- Ethernet connection
 - LAN connectors [6](#)
 - WAN connector [6](#)

F

- factory reset
 - reverting to [36](#)
 - see also *partial reset*
- Foreign Exchange Service/Station (FXS)
 - defined [67](#)
 - see also *lines*
- front
 - connectors [3](#)
 - indicators [3](#)

H

- humidity level [17](#)

I

- indicators
 - front [3](#)
 - rear [4](#)
- inspecting the contents [15](#)
- installation
 - cables, connecting [21](#), [22](#), [23](#), [24](#), [25](#), [26](#)
 - checklist [13](#)
 - connecting the hardware [21](#)
 - default static IP address configuration [30](#)
 - dynamic IP address discovery [29](#)
 - free standing unit [20](#)
 - LAN interface access [31](#)
 - network information [14](#)
 - proper location [17](#)
 - provisioning sequence, initial [30](#)
 - rack-mounting [18](#)
 - required tools and equipment [15](#)
 - reserving IP address [29](#)
 - safety recommendations [14](#)
 - selecting site for [17](#)
 - setting up the unit for the first time [29](#)
 - site log [14](#)
 - verifying [32](#)
 - wall-mounting [19](#)
 - wiring requirements [17](#)
- intended audience [viii](#)
- IP address, vocal identification of [32](#)

K

key features 2

L

LAN

- cable 32
- connectors 6
- defined 68

LEDs

- defined 68
- states 32

location, defining for installation 17

M

MAC address 29

- defined 68
- vocal identification of 32

MDI/MDIX, auto 47

Media5 download portal x

Mediatrix download portal x

mounting

- on a rack 18
- on a wall 19

O

objectives of document vii

operating temperature 17

overview of the product 1

P

partial reset 35

- see also *factory reset*

port numbering convention

- BRI connectors 11
- Ethernet connectors 10
- FXS/FXO connectors 11
- PRI connectors 10

product models 1

product overview 1

provisioning, initial sequence 30

R

rack-mounting the unit 18

rear

- connectors 4
- indicators 4

related documentation viii

Reset, partial reset procedure 35

reset, factory reset procedure 36

RJ-11. see *cabling*

RJ-45. see *cabling*

RS-232. see *cabling*

S

safety

- recommendations 45

- warnings

- Circuit Breaker (15A) 44
 - LAN Connector 44
 - No. 26 AWG 44

safety (continued)

- warnings

- Product Disposal 44

- Socket Outlet 45

- TN Power 44

site, selecting for unit 17

special vocal features

- IP address 32

- MAC address 32

standards compliance

- agency approvals 39

- CE marking 41

- emissions 39

- FCC Part 15 disclaimer 40

- FCC Part 68 disclaimer 40

- immunity 39

- Industry Canada disclaimer 41

- RoHS China 42

- safety standards 39

- telecom 39

standards supported x

straight through cable. see *cabling*

support services xi

T

technical support for end user xi

temperature, operating 17

TPE. see *cabling*

translated warning definition 43

U

unpacking the contents 15

using this manual ix

UTP. see *cabling*

V

verifying the installation 32

vocal features, special

- IP address 32

- MAC address 32

vocal unit information 32

W

wall-mounting the unit 19

WAN, connector 6

wiring, requirements for installation 17